

Quick reference guide

OptiFlex K

Manual coating equipment

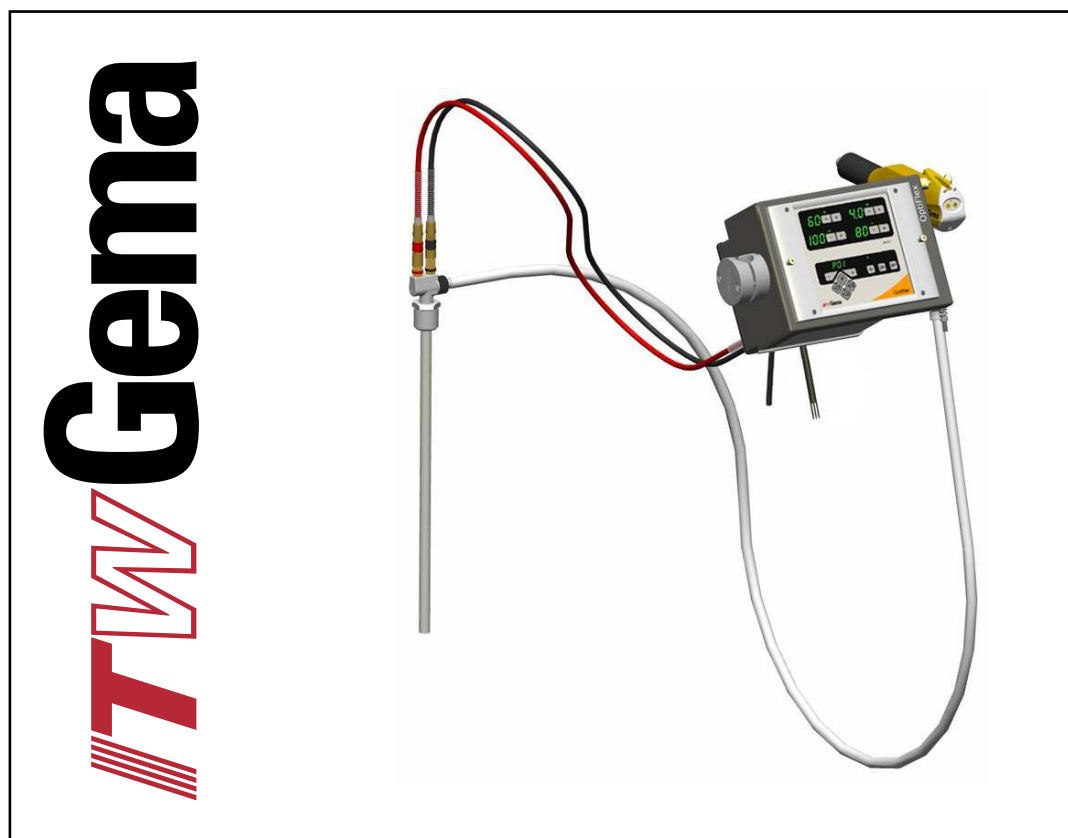

Translation of the original operating instructions

Quick reference guide OptiFlex K manual coating equipment

© Copyright 2006 ITW Gema GmbH

All rights reserved.

This publication is protected by copyright. Unauthorized copying is prohibited by law. No part of this publication may be reproduced, photocopied, translated, stored on a retrieval system or transmitted in any form or by any means for any purpose, neither as a whole nor partially, without the express written consent of ITW Gema GmbH.

OptiTronic, OptiGun, EasyTronic, EasySelect, OptiFlow and Super-Corona are registered trademarks of ITW Gema GmbH.

OptiMatic, OptiMove, OptiMaster, OptiPlus, MultiTronic and Gematic are trademarks of ITW Gema GmbH.

All other product names are trademarks or registered trademarks of their respective holders.

Reference is made in this manual to different trademarks or registered trademarks. Such references do not mean that the manufacturers concerned approve of or are bound in any form by this manual. We have endeavored to retain the preferred spelling of the trademarks, and registered trademarks of the copyright holders.

To the best of our knowledge and belief, the information contained in this publication was correct and valid on the date of issue. ITW Gema GmbH makes no representations or warranties with respect to the contents or use of this publication, and reserves the right to revise this publication and make changes to its content without prior notice.

Printed in Switzerland

ITW Gema GmbH
Mövenstrasse 17
9015 St. Gallen
Switzerland

Phone: +41-71-313 83 00

Fax.: +41-71-313 83 83

E-Mail: info@itwgema.ch

Homepage: www.itwgema.ch

Table of contents

General safety regulations	3
OptiFlex K	9
Spare parts list OptiFlex K	10
OptiStar CG07	11
Technical Data	12
Start-up and operation	13
Spare parts list OptiStar CG07	24
OptiSelect manual powder gun	31
Technical Data	32
Start-up and operation	33
Maintenance and cleaning	36
Troubleshooting guide	38
Spare parts list OptiSelect	40
OptiFlow (IG02 type)	51
Cleaning and maintenance	54
Troubleshooting guide	56
Spare parts list OptiFlow	57

General safety regulations

Safety symbols (pictograms)



The following warnings with their meanings can be found in the ITW Gema operating instructions. The general safety precautions must also be followed as well as the regulations in the operating instructions.



DANGER!

Danger due to live electricity or moving parts Possible consequences: Death or serious injury



ATTENTION!

Improper use of the equipment could damage the machine or cause it to malfunction. Possible consequences: Minor injuries or damage to equipment



NOTE!

Useful tips and other information



General information

The OptiFlex manual coating equipment is built to the latest specification and conforms to the recognized technical safety regulations and it is designed for the normal application of powder coating.

Any other use is considered as non-conform. The manufacturer is not responsible for any damage resulting from this - the risk for this is assumed by the user alone! If the OptiFlex manual coating equipment is to be used for other purposes or other substances outside of our guidelines, then ITW Gema GmbH should be consulted.

Observance of the operating, service and maintenance instructions specified by the manufacturer is also part of conformity of use.

The relevant accident prevention regulations, as well as other generally recognized safety regulations, occupational health and structural regulations are to be observed.

Furthermore, the country-specific safety regulations also must be observed.

Further safety and operation notices will be found on the accompanying CD or on the homepage www.itwgema.ch.



General danger

The start-up is forbidden until it has been established that the manual coating equipment has been set up and wired according to the EU guidelines for machinery.

Unauthorized modifications to the manual coating equipment exempts the manufacturer from any liability from resulting damages or accidents.

The operator must ensure that all users do have the appropriate training for powder spraying equipment and are aware of the possible sources of danger.

Any operating method, which will negatively influence the technical safety of the powder spraying equipment, is to be avoided.

For your own safety, only use accessories and attachments listed in the operating instructions. The use of other parts can lead to risk of injury. Only original ITW Gema spare parts should be used!

Repairs must only be carried out by specialists or by authorized ITW Gema service centers. Unauthorized conversions and modifications can lead to injuries and damage to the equipment, and the ITW Gema GmbH guarantee would no longer be valid.

These general safety regulations must be read and understood mandatory before start-up!



Electrical
danger

The connecting cables between the control unit and the spray gun must be installed in such a way, that they cannot be damaged during the operation. Please observe the local safety regulations!

The plug connections between the powder spraying equipment and the mains should only be removed when the power supply is switched off.

All maintenance activities must take place when the powder spraying equipment is switched off.

The powder coating equipment may be able to be switched on only if the booth is in operation. If the booth stops, the powder coating device must switch off too.



Explosion hazard

The control units for the spray guns must be installed and used in zone 22. Spray guns are allowed in zone 21.

Only original ITW Gema spare parts will guarantee that the explosion protection will be preserved. If damages occur by using spare parts from other manufacturers, the warranty or compensation claim is void!

Conditions leading to dangerous levels of dust concentration in the powder spraying booths or in the powder spraying areas must be avoided. There must be sufficient technical ventilation available, to prevent a dust concentration of more than 50% of the lower explosion limit (UEG = max. permissible powder/air concentration). If the UEG is not known, then a value of 10 g/m³ should be considered (see EN 50177).

All unauthorized conversions and modifications to the electrostatic spraying equipment are forbidden for safety reasons.

No safety devices should be dismantled or put out of operation.

The operating and job instructions has to be written in an understandable form and in the language of the persons employed, and has to be announced in a suitable place in the working area.



Slip hazard

Powder lying on the floor around the powder spraying equipment is a potentially dangerous source of slipping. Booths may be entered only in the places suitable for it.

Static charges

Static charges can have the following consequences: Charges to people, electric shocks, sparking. Charging of objects must be avoided by a proper grounding.

Grounding

All electricity conducting parts found in the workplace of 5 meters around each booth opening, and particularly the objects to be coated, have to be grounded. The earthing resistance of each object must amount to maximally 1 MOhm. This resistance must be checked/tested regularly when starting work.

The condition of the work piece attachments, as well as the hangers, must guarantee that the work pieces remain grounded. The appropriate measuring devices must be kept ready in the workplace, in order to check the grounding.

The floor of the coating area must conduct electricity (normal concrete is generally conductive).

The supplied grounding cable (green/yellow) must be connected to the grounding screw of the electrostatic manual powder coating equipment. The grounding cable must have a good metallic connection with the coating booth, the recovery unit and the conveyor chain, respectively with the suspension arrangement of the objects.



Observe the grounding regulations



Fire and smoke prohibition

Smoking and igniting fire are forbidden in the entire plant area! All spark-generating works are forbidden!



The stay for persons with cardiac pacemakers is forbidden

As a general rule for all powder spraying installations, persons with pacemakers should never enter high voltage areas or areas with electromagnetic fields. Persons with pacemakers should not enter areas with powder spraying installations!



Photographing with
flashlight is forbidden

Photographing with flashlight can lead to unnecessary releases and/or disconnections by safety devices.



Disconnect from mains
before maintenance
works take place

Disconnect the plugs before the machines are opened for maintenance or repair.

The plug connections between the powder spraying equipment and the mains should only be removed when the power supply is switched off.



As far as it is necessary, the operating firm must ensure that the operating personnel wear protective clothing (e.g. facemasks).

The operating personnel must wear electrically conductive footwear (e.g. leather soles).

The operating personnel should hold the gun with bare hands. If gloves are worn, these must also conduct electricity.

**These general safety regulations must
be read and understood mandatory be-
fore start-up!**

OptiFlex K

Scope of delivery

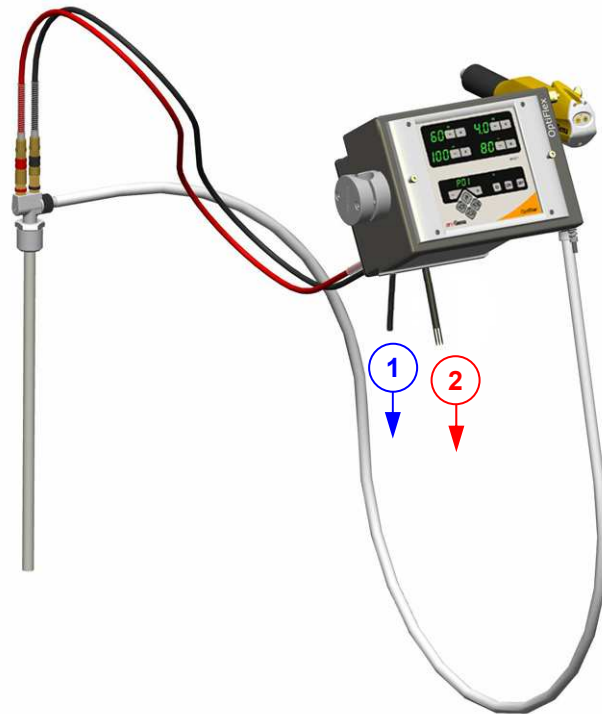

- ① → max. 10 bar / 145 psi
min. 6 bar / 87 psi
- ② → 100-240 VAC, 50-60 Hz

Spare parts list OptiFlex K

OptiFlex K - complete (1002 619)

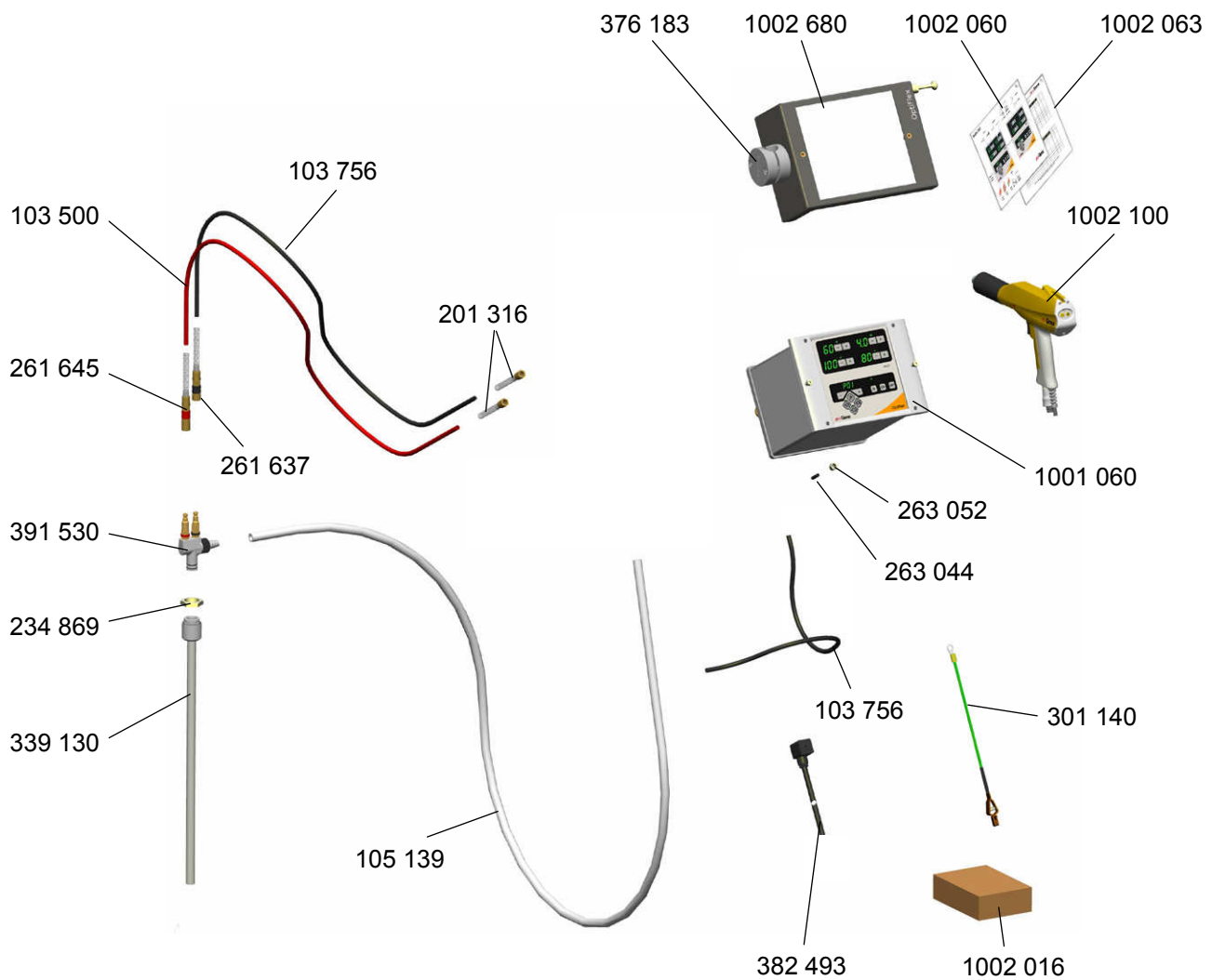

OptiStar CG07

Operating modes

The OptiStar CG07 Manual gun control unit can be operated with two operating modes. According to the selected application mode, the spray voltage and the spray current are automatically adjusted and limited.

Predefined operating mode (Preset mode)

The CG07 Gun control unit provides three predefined application modes (flat parts, complicated parts and recoat parts already painted one time). When operating in this mode, the spray voltage and spray current are automatically set and limited.

In this operating mode, current (μA) and high voltage (kV) are preset, powder and air volume can be adjusted and saved. The powder and air volume are stored separately for each predefined application mode.

User-defined operating mode (Program mode)

In this operating mode, 20 individually definable programs (P01-P20) are available. These programs are automatically saved and can be recalled again as the application requires.

The values for current, high voltage, powder output, total air, electrode rinsing air and fluidizing air (if available) can be set as needed for a given application.



Note:

The specified values in the 20 programs and 3 application modes are saved automatically, without confirmation, after a two second delay and the display changes from preset values to actual values!

Technical Data

OptiStar CG07 Manual gun control unit

Connectable guns

OptiStar CG07	connectable
OptiSelect GM02	yes
OptiGun GA02	only with trigger adapter
PG1	yes
PG2-A / PG2-AX	only with trigger adapter
PG3-E**	yes
TriboJet*	yes, with adapter

* The gun type must be adjusted (reference chapter "Additional options"). The Tribo gun is not type approved (ATEX).



** Only for enamel powder, the gun is not type approved (ATEX).



Attention:

The OptiStar CG07 Manual gun control unit can only be used with the specified gun types!

Electrical data



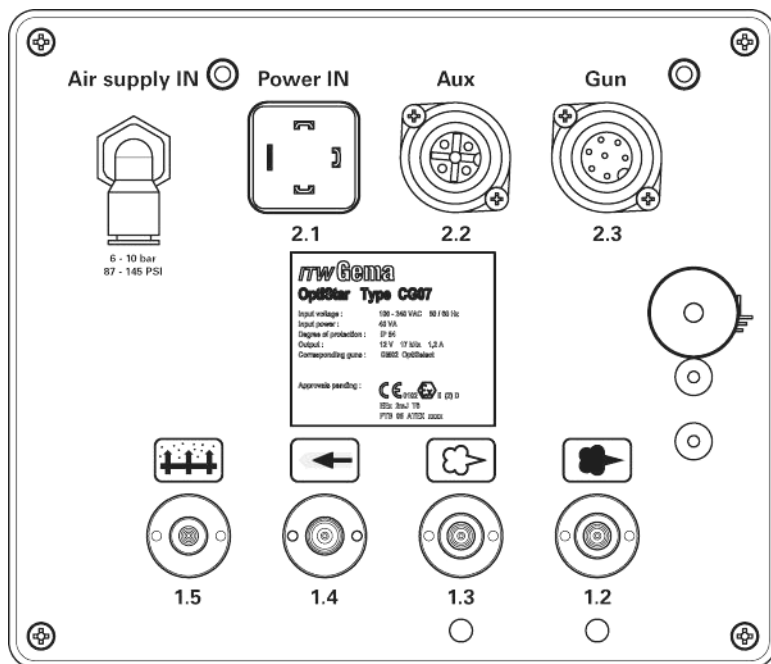

OptiStar CG07	
Mains input voltage	100-240 VAC
Operating frequency	50-60 Hz
Input power (without vibrator)	40 VA
Nominal output voltage (to the gun)	max. 12 V
Nominal output current (to the gun)	max. 1 A
Vibrator connection and power (on the Aux output)	110/220 VAC max. 100W
Protection type	IP54
Temperature range	0°C - +40°C (+32°F - +104°F)
Max. operating temperature	85°C (+185°F)
Approvals	  II (2) 3 D PTB05 ATEX 5009

Start-up and operation

Connections



OptiStar CG07Gun control unit - connections on the rear wall

Connection	Description
1.1 Air Supply IN	Compressed air connection (6-10 bar / 87-145 PSI)
2.1 Power IN	Mains cable connection (100-240 VAC)
2.2 Aux	Vibration motor connection for OptiFlex B
2.3 Gun	Gun cable connection
1.5	Fluidizing air connection 
1.4	Electrode rinsing air connection 
1.3	Supplementary air connection 
1.2	Conveying air connection 
	Grounding connection 

Connection guide

1. Check the compressed air connection from filter unit to control unit. Connect the compressed air supply hose from the compressed air circuit directly to the filter unit main connection on the rear side of the equipment (1/4" female BSP)



Note:

The compressed air must be free from oil and water!

2. Connect the black hose for fluidizing air (electrically conductive) to the output **1.5** on the rear side of the control unit
3. Connect the grounding cable to the control unit with the grounding screw, and the 5 m long grounding cable with the clamping clip to the booth or the conveyor. Check ground connections with Ohm meter and ensure 1 MOhm or less
4. Connect the gun cable plug to the socket **2.3** on the rear side of the control unit
5. Connect the rinsing air hose to the electrode rinsing air output **1.4** and to the powder gun
6. Insert the injector, connect the powder hose to the injector and to the powder gun
7. Connect the red hose for conveying air to the corresponding output **1.2** on the rear side of the control unit and to the injector
8. Connect the black hose for supplementary air to the corresponding output **1.3** on the rear side of the control unit and to the injector (this hose is electrically conducting)
9. Connect the mains cable to the **2.1 Power IN** plug and tighten with provided screw



Note:

If no vibration motor (OptiFlex B) is connected, the 2.2 Aux output is to be locked tightly with the provided protection cap!

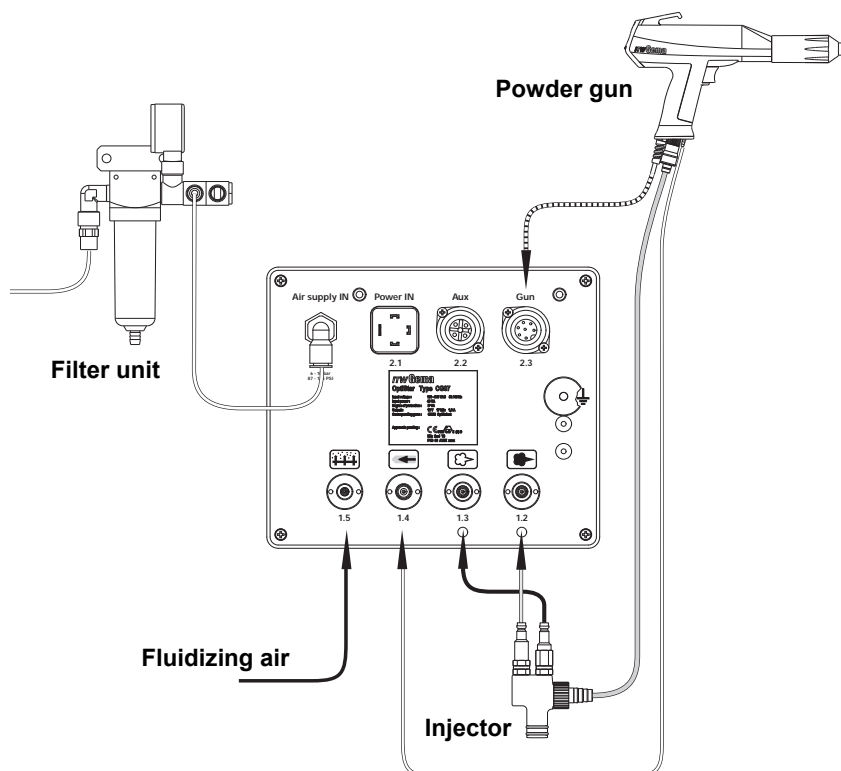

Connecting guide - overview

Pin assignment

Power IN

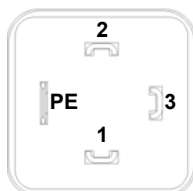

Power IN connection

- 1 Neutral conductor (power supply)
- 2 Phase conductor (100-240 VAC)
- 3 Stirrer output
- PE Ground PE

Aux

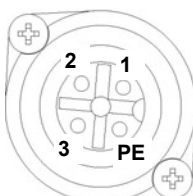

Aux connection

- 1 Vibrator phase output
- 2 Neutral conductor
- 3 Not used
- PE Ground PE

Gun

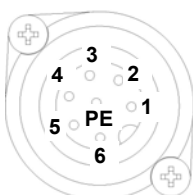

Gun connection

- 1 Ground
- 2 Remote control 1 (GM02)
- 3 Chassis ground
- 4 Trigger
- 5 Remote control 2 (GM02)
- 6 Oscillator
- PE Ground PE

Initial start-up

Setting the device type



Adjust the corresponding device type (fluidizing, box or stirrer device) by pressing the key **T16**.



Note:

If the control unit is supplied as a component of an OptiFlex complete unit, then the corresponding system parameter is set correctly by the factory!

Manual devices are subdivided into fluidizing, box or stirrer types. These types differ in the control of the vibrator output and the behavior of the fluidizing air.

Device type	AUX output function	Fluidizing air function
Fluidizing device (OptiFlex F)	Always Off (no vibration)	Fluidizing air is controlled by two different methods: Turning on the fluidization key T16 will feed air to the hopper until key is turned off Triggering the gun is turning on the fluidization too, fluidization can be turned off with key T16
Box device (OptiFlex B)	Vibration On during triggering, delay of 1 minute after releasing gun trigger The key T16 switches the vibration On and Off	Fluidizing air is switched On parallel by the trigger. It runs after for 1 minute The key T16 switches the fluidization On and Off parallel to the vibration
Stirrer device (OptiFlex S)	Stirrer On when gun triggered	No fluidization, no function of key T16
Manual unit with fluidization (OptiFlex S Fd)	Stirrer On when gun triggered	Fluidization is switched On and Off with trigger The key T16 switches Off the fluidization, it can only be turned On by pressing the key again



Note:

The system parameter P0 of the manual unit may not be set on 3 (automatic unit)!

A wrong parameterization leads to various malfunctions!

Preparing the powder hopper/container

Prepare the powder hopper or powder box according to manual equipment type (OptiFlex F, B, S, L etc.), reference the operating manual for the equipment type being used.

Switch on the booth

Switch on the powder coating booth according to its operating manual.

Daily start up

The daily start-up of the OptiStar CG07 Manual gun control unit takes place by the following steps:

Select the operating mode

Select the application mode with three predefined modes (Preset mode) or the user-defined program mode with 20 user-defined programs (Program mode).



1. Turn on the gun control unit with the **ON** key
2. Select the corresponding application mode with key **T12** (for Program mode) or keys **T13/T14/T15** (for Preset mode)

The predefined mode automatically set values for high voltage and spraying current:

Presetting	Desired μA	Desired kV
Flat parts	100	100
Complicated parts	22	100
Overcoating	10	100

Predefined application mode (Preset mode)

Select the preset mode with the application keys **T13/T14/T15**. The LED of the corresponding key illuminates. No program number will be shown on the display **A5**. The air values can be individually specified and are automatically stored in the corresponding program.



Application mode for flat parts

This application mode is suitable for the coating of simple, flat workpieces without larger cavities.



Application mode for complicated parts

This application mode is suitable for the coating of three-dimensional workpieces with complicated shapes (e.g. profiles).



Application mode for recoating parts already coated

This application mode is suitable for recoating of workpieces which are already coated.



Exiting the Preset mode

Exit the Preset mode with the keys **T10**, **T11** or **T12**. The preset values of the Program mode used before the Preset mode are displayed by the control unit memory.





User-defined mode (Program mode)

Select this application mode with the key **T12**. Here, 20 user-defined programs can be set and saved. The programs 1-20 were loaded with pre-sets by factory (4.0 Nm³/h total air, 60% powder output, 80 kV high voltage, 80 µA spray current, 0.2 Nm³/h electrode rinsing air and 1.0 Nm³/h fluidizing air).

Setting powder output and powder cloud

The powder output is dependent on the selected powder amount (in %) and the adjusted total air volume.

Setting the total air volume



1. Adjust the total air volume with the keys **T3/T4** (see also the injector operating manual)
 - Adjust the total air volume according to the corresponding coating requests

Setting the powder output



1. Adjust the powder output volume (e.g. according to the desired coating thickness)
 - The selection takes place with the keys **T1/T2** on the control unit or with the +/- keys on the rear side of the powder gun (OptiSelect gun type). Factory default setting of 60% is recommended for initial spraying. The total air volume is thereby kept constant automatically by the control unit
2. Check the powder fluidizing in the hopper and ensure you have a small simmer or very low boiling action
3. Point the gun into the booth, press the gun trigger and visually check the powder output



Note:

As a factory default value, a powder rate of 60% and a total air volume of 4 Nm³/h are recommended. By inserting values, which the equipment cannot convert, the operator is made aware by flashing of the appropriate display and a temporary out of range message!

Setting the electrode rinsing air

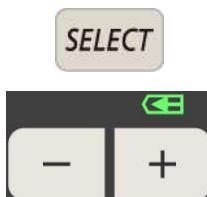

1. Adjust the correct electrode rinsing air according to the applied nozzles (deflector plate, flat jet nozzle), see note below for default/starting values
 - Press key **T9 (SELECT)**
The second display level is switched over
 - Press keys **T7/T8**:
Here, the corresponding air volume value is entered
 - If this display level is not operated for 3 seconds, the first display level is switched over independently

**Note:**

By using flat jet nozzles, the factory default value is approx. 0.2 Nm³/h, by using round jet nozzles with air-rinsed deflector plates, the factory default value is approx. 0.5 Nm³/h!

Setting the fluidizing

The fluidizing can be adjusted on the OptiFlex B, OptiFlex S and OptiFlex F manual device.

The powder fluidizing depends on the powder type, the air humidity and the ambient temperature. Fluidizing and vibration start by switching on the control unit.

Procedure:

1. Adjust the air mover by turning the ball valve fully open and adjusting needle valve as required. The ball valve and needle valve are located on the air mover (OptiFlex F)
2. Open the powder hopper cover
3. Press key **T9 (SELECT)**
The second display level is switched over
4. Adjust the fluidizing air with the keys **T5/T6**
 - If the adjustment keys (+ or -) are not operated after 3 seconds, the display will go back to the **µA** display
 - The powder should "simmer" inside the hopper. Occasional mixing of the powder might be required
5. Close the cover again
6. According to the device type, stirrer, vibration and/or fluidizing can be switched on now



Powder coating

**Attention:**

Make sure first, that all electrically conductive parts within 5 m of the coating booth are grounded!



1. Take the gun into the hand and hold it into the coating booth, but do not yet direct it to the object to be coated
2. Select the operating mode:
Select the operating mode with program key **T12** or application keys **T13/T14/T15**. The LED of the corresponding application key illuminates
3. Adjust powder delivery and total air settings as required. This will need to be done as the gun is triggered to visualize the spray pattern
4. Press the powder gun trigger
5. Coat the objects

Remote control by GM02 manual gun



Various functions can be remotely controlled with the + and - keys on the back side of the powder gun (OptiSelect gun type):

- Adjust the powder output by pressing the + or - key on the gun. The powder output will be increased or decreased accordingly
- Change application modes (Preset mode/Program mode) by pressing the + and - keys on the gun at the same time. The change takes place counterclockwise. Check by observing the key LEDs on the control unit



Note:

By pressing one of the keys, the preset values display will be shown!

Shut-down

The shut-down of the OptiStar CG07 Manual gun control unit takes place in following steps:

1. Remove the powder gun trigger
2. Switch off the control unit
3. Switch off the Airmover (OptiFlex F)



Note:

The adjustments for high voltage, powder output, electrode rinsing air and fluidizing remain stored!

If in disuse during several days

1. Remove the mains plug
2. Clean the coating equipment (see the corresponding operating manual)
3. Turn off the compressed air main supply

Saving programs



Note:

The values in programs 1-20 and the 3 preset application modes are saved automatically, without confirmation!

Error diagnosis of the software

General information

The correct function of the OptiStar CG07 Manual gun control unit is constantly monitored. If the equipment software determines a fault, an error message is indicated with an error code. Following is monitored:

- High voltage technology
- Air technology
- Power supply

Help codes

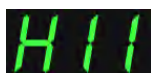

The error diagnosis codes (error codes) are shown in the display **A5**. The error codes are stored in an error list in the order of their occurrence. Each error in the list must be individually acknowledged with the keys **T10** or **T11**.

The error codes are shown with the format **Hnn**, whereby **nn** is the numeric code, if necessary with a leading zero.

The errors are displayed in the order of their occurrence. The keys **T10** and **T11** cannot be used for other functions, as long as an error code is shown on **A5**.

Here is the complete listing of all error codes possible for the OptiStar CG07 Manual gun control unit:

Code	Description	Criteria	Remedy
Pneumatics:			
H06	Trigger valve (main solenoid valve)	Solenoid coil current lower than preset limiting value Valve defective, main board or cable defective	Main solenoid valve error, connection cable from main solenoid valve to basic electronics is missing, check main solenoid valve
H07	Supplementary air volume too high (total air setting on display)	The preset value for supplementary air is too high compared to your conveying air setting	Reduce supplementary air value or increase conveying air value to balance air volume to injector and clear help code
H08	Conveying air volume too high (powder % setting on display)	The preset value for conveying air is too high compared to your supplementary air setting	Reduce conveying air value or increase supplementary air value to balance air volume to injector and clear help code
H09	Powder output higher than 100%	The powder output multiplied with the powder hose length factor and the daily correction value is larger than 100% Daily correction value too large	Reduce powder output Reduce daily correction value
H10	Conveying air range lower deviation	The theoretical value for conveying air falls below minimum Total air is smaller than minimum	Limit conveying air to conveying air minimum

Code	Description	Criteria	Remedy
High voltage:			
H11	Gun error	No oscillation, cable broken, oscillator or gun defective	Replace gun cable, cascade etc.
Power supply:			
H20	Overvoltage +15V supply	Power pack defective or over-loaded	Replace the power pack, if error is permanent
H21	Undervoltage +15V supply	Power pack defective or over-loaded	Replace the power pack, if error is permanent
H22	Undervoltage -15V supply	Power pack defective or over-loaded	Replace the power pack, if error is permanent
H23	Undervoltage +5V supply	Power pack defective or over-loaded	Replace the power pack, if error is permanent
EEPROM (equipment memory):			
H24	EEPROM content invalid	EEPROM error	Load factory settings initialize EEPROM (see therefore in chapter "RAM reset")
H25	Timeout during EEPROM writing	EEPROM error	
H26	Values not correctly stored in EEPROM during switching off	EEPROM error	
Throttle motors:			
H60	Conveying air reference position not found	Throttle motor or needle blocked, limit switch defective, throttle motor error	Calibrate again, replace throttle valve
H61	Supplementary air reference position not found	Throttle motor or needle blocked, limit switch defective, throttle motor error	(see above)
H62	Electrode rinsing air reference position not found	Throttle motor or needle blocked, limit switch defective, throttle motor error	(see above)
H63	Shaping air / fluidizing air reference position not found	Throttle motor or needle blocked, limit switch defective, throttle motor error	(see above)
H64	Conveying air throttle does not move	Short circuit in limit switch, throttle motor defective	(see above)
H65	Supplementary air throttle does not move	Short circuit in limit switch, throttle motor defective	(see above)
H66	Electrode rinsing air throttle does not move	Short circuit in limit switch, throttle motor defective	(see above)
H67	Shaping air / fluidizing air throttle does not move	Short circuit in limit switch, throttle motor defective	(see above)
H68	Conveying air position lost	Lost steps, limit switch defective, throttle motor defective	(see above)
H69	Supplementary air position lost	Lost steps, limit switch defective, throttle motor defective	(see above)
H70	Electrode rinsing air position lost	Lost steps, limit switch defective, throttle motor defective	(see above)
H71	Shaping air / fluidizing air position lost	Lost steps, limit switch defective, throttle motor defective	(see above)

Help codes list

The last appeared four errors are stored in a list by the software. If an error appears, which is already in the list, it will not be listed again. If the list is full, no more new entries are added.

Appearance of errors

It is possible that an error appears just shortly, but after the acknowledgement it will disappear. In this case, switch off the OptiStar control unit and switch it on again (Reset by restarting).

Spare parts list OptiStar CG07

Ordering spare parts

When ordering spare parts for powder coating equipment, please indicate the following specifications:

- Type and serial number of your powder coating equipment
- Order number, quantity and description of each spare part

Example:

- **Type** OptiFlex K manual coating equipment,
Serial number 1234 5678
- **Order no.** 203 386, 1 piece, Clamp - Ø 18/15 mm

When ordering cable or hose material, the required length must also be given. The spare part numbers of this yard/meter ware is always marked with an *.

The wear parts are always marked with a #.

All dimensions of plastic hoses are specified with the external and internal diameter:

Example:

Ø 8/6 mm, 8 mm outside diameter (o/d) / 6 mm inside diameter (i/d)



WARNING!

Only original ITW Gema spare parts should be used, because the hazardous location approval will be preserved that way! The use of spare parts from other manufacturers will invalidate the ITW Gema guarantee conditions!

OptiStar CG07 Manual gun control unit

	OptiStar CG07 Manual gun control unit - complete	1001 060
1	Front plate - see corresponding spare parts list	
2	Housing and power pack - see corresponding spare parts list	
3	Rear wall - see corresponding spare parts list	
4	Protective cover	1004 426



OptiStar CG07 Manual gun control unit



Manual gun control unit - outside rear wall

	OptiStar CG07 rear wall - complete (aluminium version)	1000 063
	OptiStar CG07 rear wall - complete (steel version)	1004 500
1	Rear wall (aluminium version)	1000 067
	Rear wall (steel version)	1004 175
2	OptiStar CG07 vibrator connection, assembled	1001 177
3	Milled nut - M6	200 433
4	Hose connection - complete, Ø 6/4 mm (aluminium version)	1001 520
	Hose connection - complete, Ø 6/4 mm (steel version)	1004 184
5	Hose connection - complete, Ø 8/6 mm (aluminium version)	1001 519
	Hose connection - complete, Ø 8/6 mm (steel version)	1004 183
6	Rectus quick release connection - complete (aluminium version)	1001 517
	Rectus quick release connection - complete (steel version)	1004 181
7	Gun connection CG07, assembled	1001 179
8	Mains connection CG07	1001 176
9	Cap screw - M3x8 mm	202 363
10	Cap screw - M3x12 mm (not shown)	216 747
	Shock protection (is fixed on the rear wall, not shown)	1001 058
11	Fixing screws for shock protection (2 pieces) - M5x12 mm	216 348
	Corona/Tribo adapter (not shown)	1001 869
	Protection cap for 2.2 Aux connection (not shown)	206 474
	Connecting cable (power supply) for 2 control units operation (not shown)	1001 867

Manual gun control unit - outside rear wall

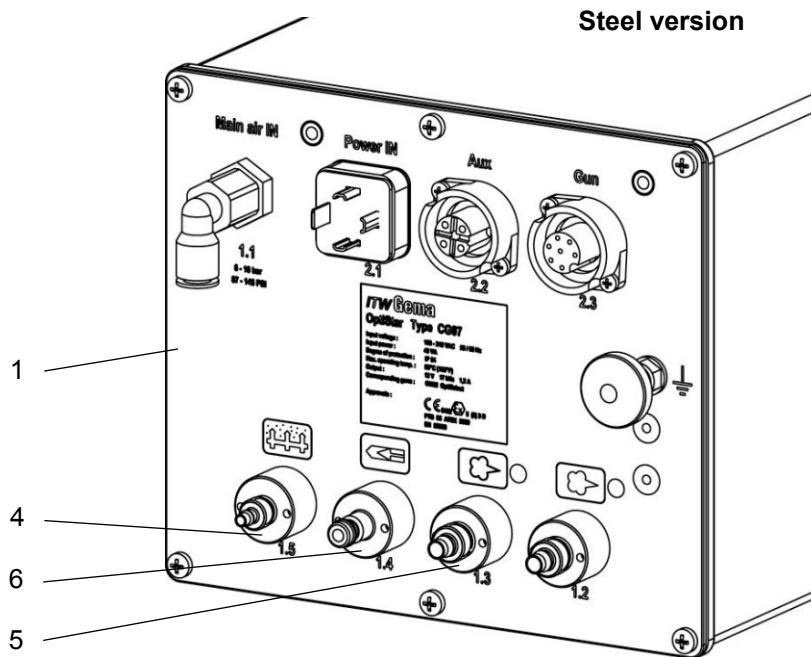
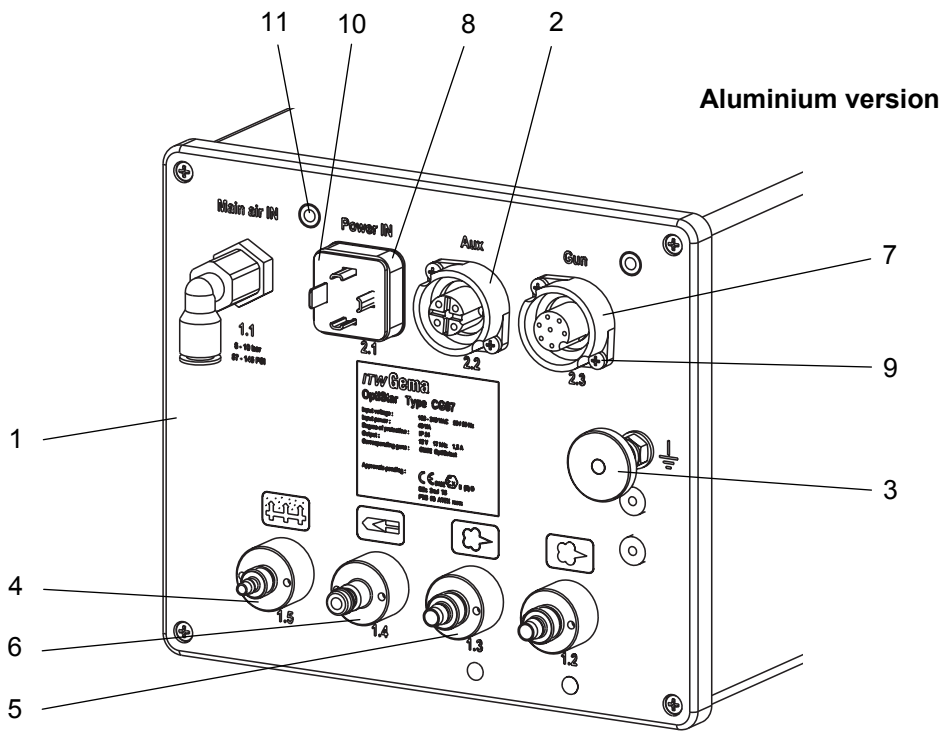

Manual gun control unit - outside rear wall

OptiStar CG07 Manual gun control unit - rear wall

1	Pneumatic group - complete	1001 029
2	Throttle motor - completely assembled	1000 064
3	Main solenoid valve cable - CG07	1001 410
4	Spring washer - M3 R	201 880
5	Hexagon nut - M3	202 142
6	Cylinder screw - M3x16 mm	221 074
7	Screw-in nipple - 1/8", Ø 6 mm, OR	262 315
8	Fluidizing pad - 1/8"a	237 264
9	Gasket (steel version only)	1003 528
10	Cap screw K-SL - M4x16 mm (steel version only)	216 801
11	O-Ring - Ø 8.73x1.78 mm (steel version only)	248 428

Aluminium version

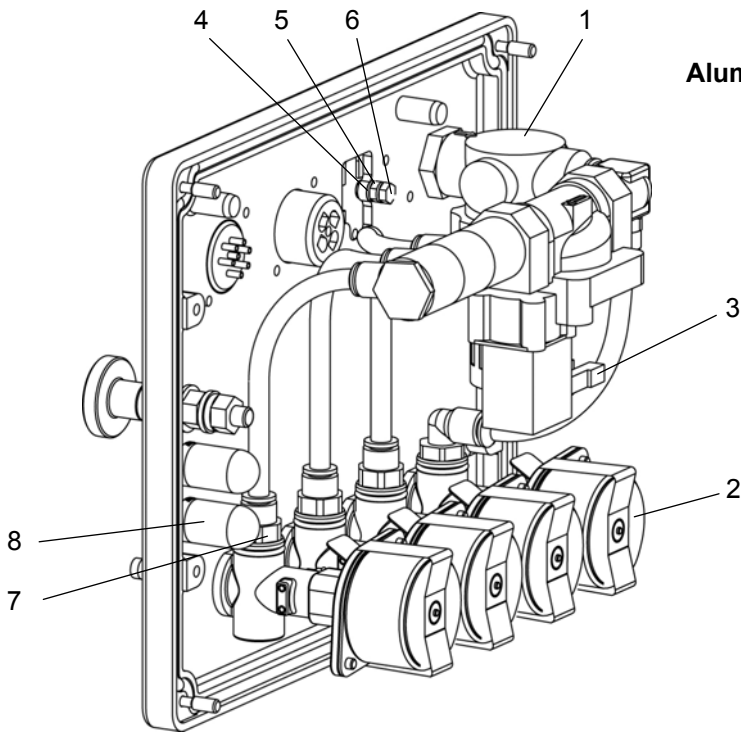

Steel version

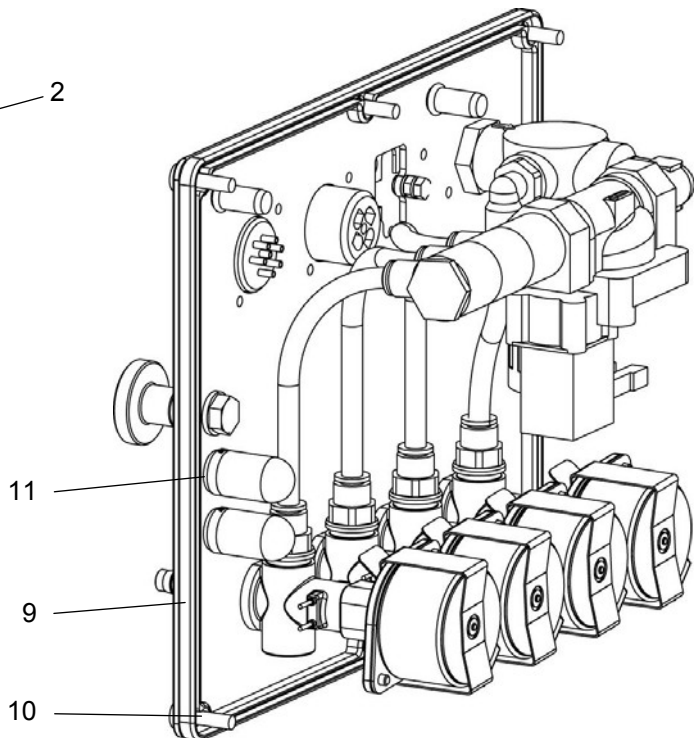

OptiStar CG07 Manual gun control unit - housing and power pack

1	Housing - CG07 control unit (aluminium version)	1001 435
	Housing - CG07 control unit (steel version, not shown)	1004 200
2	Power pack - 15 VDC	374 059
3	Power pack connection cable, assembled	1000 388
4	Connection cable, assembled	1001 178
5	Standoff - Ø 4/4.8/4.8 mm, PA	263 508

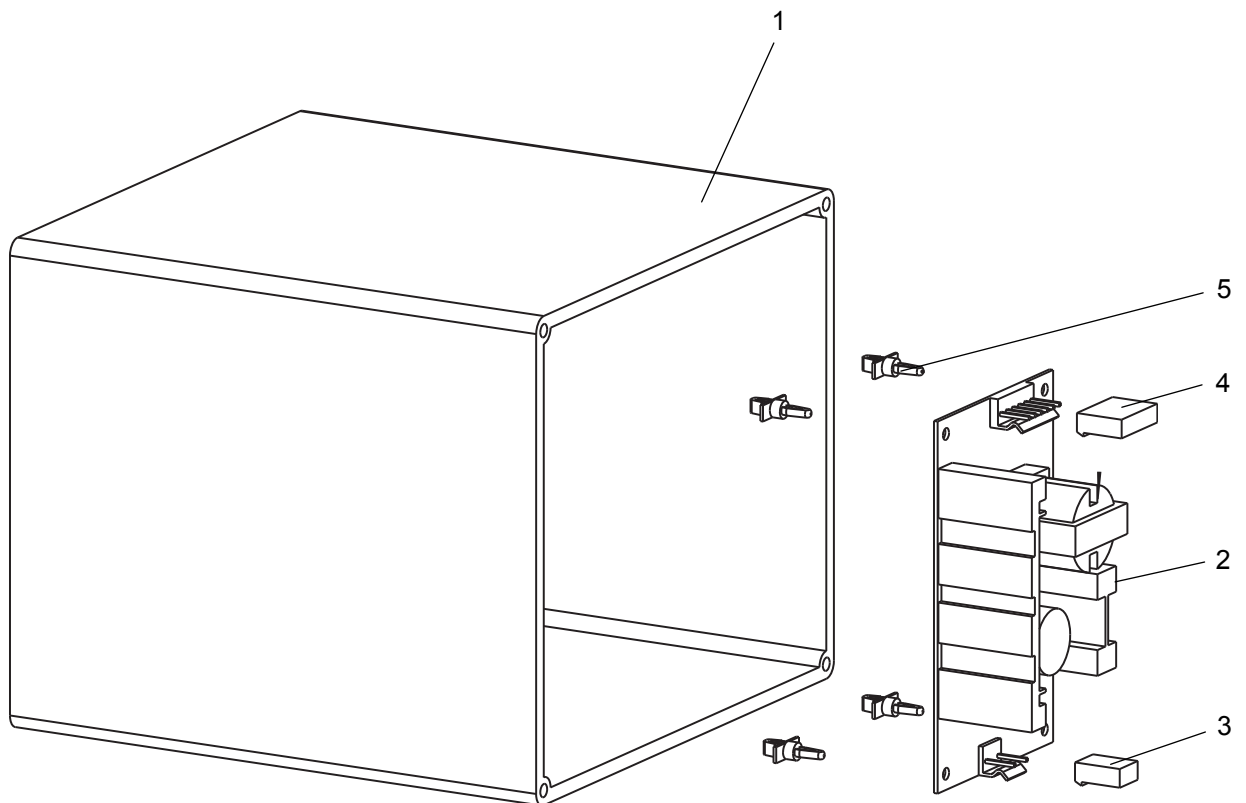

OptiStar CG07 Manual gun control unit - power pack and housing

OptiStar CG07 Manual gun control unit - front plate

	Front plate - complete	1000 395
1	Front plate with foil keyboard	1000 394
3	OptiStar mainboard V1.0 - complete, with display	1000 875
4	Locknut - M3	262 498
5	Washer - Ø 3.2/7x0.5 mm	201 944
6	Standoff - 6x3.4x6.5 mm	1001 925
7	Standoff - 6x3.4x15.5 mm	1001 926
8	Compression spring - 0.5x6.3x13.5 mm	230 251
9	Special screw	1000 400

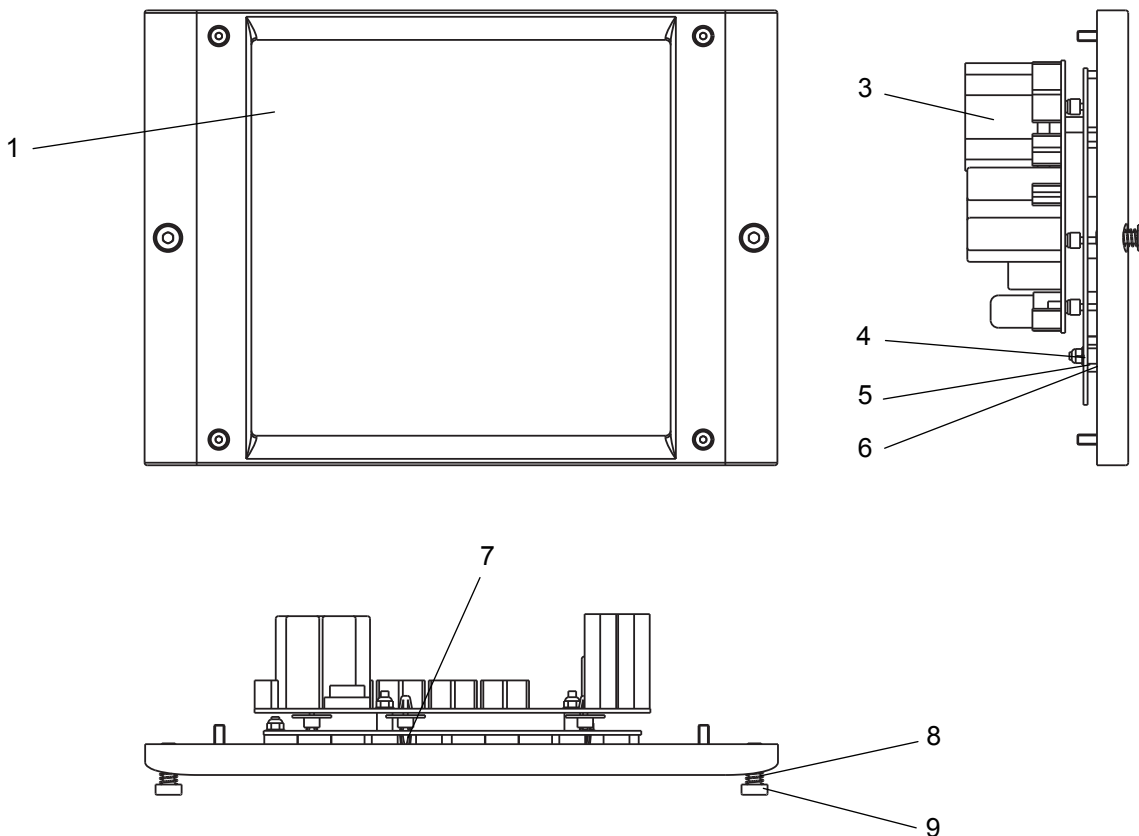

OptiSelect manual powder gun

Scope of delivery



OptiSelect manual powder gun

- An OptiSelect manual powder gun with gun cable, 6 m
- Rinsing air hose, 6 m
- Flat jet nozzle, complete
- Round jet nozzle with deflector kit (Ø 16, 24 and 32 mm)
- Cable binder with Velcro closure
- Gun cleaning brush
- Spare parts kit

Technical Data

OptiSelect manual powder gun

Electrical data

OptiSelect manual powder gun	
Ignition protection	Ex 2 mJ T6
Temperature range	0°C - +40°C (+32°F - +104°F)
Max. operating temperature	85°C (+185°F)
Approvals	  II 2 D PTB05 ATEX 5007



Attention:

The OptiSelect manual powder gun can be connected to the OptiStar and the OptiTronic (without remote control) control units!

Start-up and operation

Connecting guide



1. Connect the compressed air supply hose from the compressed air circuit directly to the filter unit main connection on the rear side of the equipment (connecting 1/4" BSP male thread). The compressed air connection from the filter unit to the control unit must be connected

Note:

The compressed air must be free from oil and water!

2. Connect the black hose for fluidizing air to the output **1.5** on the rear side of the control unit
3. Connect the grounding connection cable to the control unit with the grounding screw, and connect the 5 m long grounding cable with the clamping clip to the booth or the suspension device
4. Connect the gun cable plug to the socket **2.3** on the rear side of the control unit
5. Connect the rinsing air hose to the electrode rinsing air output **1.4** and to the powder gun
6. Attach the injector, connect the powder hose to the injector and to the powder gun
7. Connect the red hose for conveying air to the corresponding output **1.2** on the rear side of the control unit and to the injector
8. Connect the black hose for supplementary air to the corresponding output **1.3** on the rear side of the control unit and to the injector (this hose is electrically conductive)
9. Connect the mains cable to the plug **2.1 Power IN** and screw it on

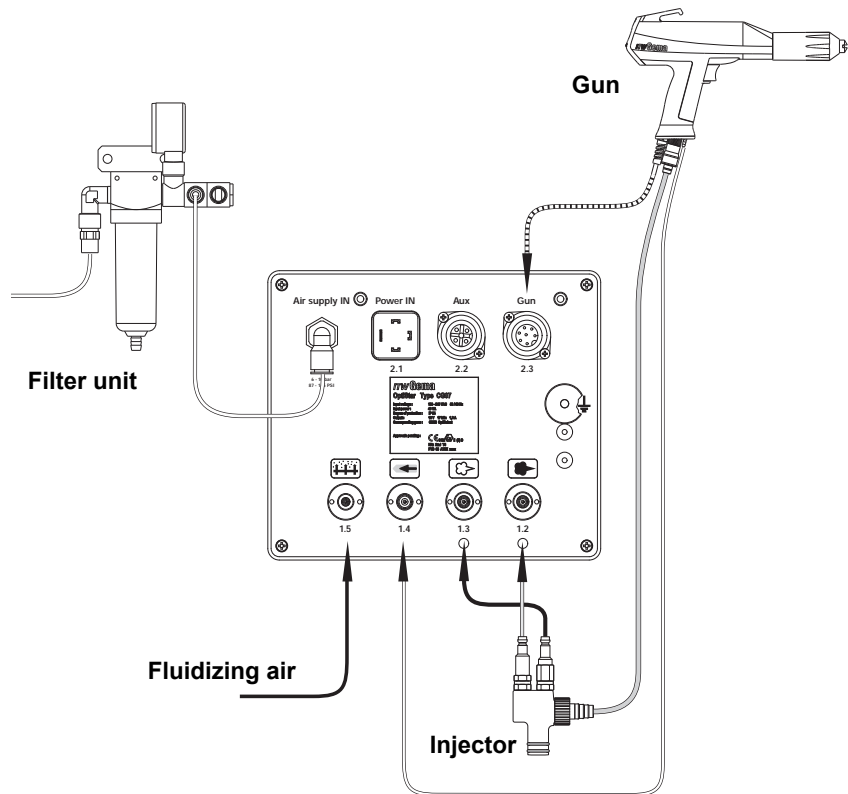

Connecting guide - overview

Function check

1. Turn on the gun control unit
2. Press the desired application key (Preset or Program Mode) on the control unit (see gun control unit operating instructions)
3. Pick the gun up and point it at a grounded object, at a distance of approx. 20 cm
4. Press the powder gun trigger
 - The display for current and high voltage on the control unit shows the actual value. The high voltage is present in the OptiSelect gun, and the LED illuminates
 - The high voltage can be set with the corresponding keys (See also the control unit operating instructions)
5. Select the powder output and total air volume
 - The display indicates the powder output in % and total air volume in m³/h
6. Press the corresponding key for the rinsing air on the control unit (according to the nozzle used)
7. Check the remote control by pressing the + or - key on the back of the powder gun, and the modified powder output value is displayed on the control unit. By simultaneous pressing of the + and - key, the application modes can be changed on the control unit

When all the checks are positive, the gun is ready for operation.



Note:

If a malfunction occurs, see the troubleshooting guide as well as the gun control operating manual!

Start-up

Switch on the control unit

1. Press the **ON** power switch on the control unit.
The displays illuminate and the control unit is ready for operation



Note:

The next procedure for starting-up the OptiSelect manual powder gun is explicitly described in the OptiStar CG07 control unit operating instructions (chapter "Initial start-up" and "Daily start up")!

Maintenance and cleaning



Note:

Regular and conscientious maintenance increases the operating life of the unit and ensures a longer, more constant coating quality!

Daily maintenance

1. Clean the gun, see chapter "Cleaning"

Weekly maintenance

1. Clean the gun, see chapter "Cleaning"
2. Check the grounding connections of the coating booth, the suspension devices of the work pieces, or the conveyor chain

Cleaning

Cleaning the OptiSelect manual powder gun

Frequent cleaning of the gun serves to guarantee the quality of the coating.



Note:

Before cleaning the powder gun, switch off its control unit. The compressed air used for cleaning must be free from oil and water!

Daily

1. Blow off the outside of the gun and wipe clean etc.

Weekly

2. Remove powder hose from connector
3. Remove the spray nozzle from the gun and clean it with compressed air
4. Blow through the gun with compressed air, beginning from the connection in flow direction
5. Clean the integrated gun tube with the supplied brush, if necessary

6. Blow through the gun again with compressed air
7. Clean the powder hose
8. Reassemble the gun and connect it

**Attention:**

Cleaning the OptiSelect manual powder gun with the following solvents is not allowed:

Ethylene chloride, acetone, ethyl acetate, methyl ethyl ketone, methylene chloride, premium gasoline, turpentine, tetrachloromethane, toluene, trichloroethylene, xylene!

**Note:**

Only cleaning agents with a flash point of a least 5 Kelvin above the ambient temperature, or cleaning places with technical ventilation are allowed!

Cleaning the spray nozzles

Daily or after every shift

- Clean the inside and outside of the spray nozzle with compressed air.
Never immerse the parts in solvents!
- Check the seating of the spray nozzles.
Make sure that the threaded sleeve is always tightened well. If the spray nozzle is not completely tight, the danger exists, that the high voltage of the gun can flash over, which can lead to damage to the powder gun!

Weekly

- Remove the spray nozzles and clean inside with compressed air. If sintering should have formed, then this is to be removed!

Monthly

- Check the spray nozzles for wear

The flat jet nozzle is to be replaced, if:

- the spray pattern is no longer a regular oval
- deeper grooves in the nozzle slot or even the wall thickness is no longer visible
- the wedge of the electrode holder is worn down

Nozzles with deflectors:

- if the wedge of the electrode holder is worn down, then the electrode holder is to be replaced

Troubleshooting guide

General information

Fault	Criteria	Solution
H11 (error message on control unit)	Gun not connected Gun plug or gun cable defective Remote control on powder gun defective	Connect the gun Replace corresponding part or send in for repair Replace remote control (gun cap)
Gun LED remains dark, although the gun is triggered	High voltage adjustment is set too low Gun plug or gun cable defective LED on gun defective	Increase high voltage Replace defective part or send in for repair Replace gun back cover
Powder does not adhere to object, although the gun is triggered and sprays powder	High voltage and current deactivated High voltage cascade defective Objects are not properly grounded	Check the high voltage and current setting Send in the gun for repair Check the grounding

Fault	Causes	Fault elimination
<p>The gun does not spray powder, although the control unit is switched on and the gun is triggered</p>	<p>Compressed air not present</p> <p>Too little conveying air</p> <p>Injector or nozzle on the injector, powder hose or powder gun clogged</p> <p>Insert sleeve in the injector worn or not inserted</p> <p>Nozzle in the injector clogged</p> <p>Fluidizing not running</p> <p>No conveying air:</p> <p>Motor throttle defective</p> <p>Solenoid valve defective</p> <p>Front plate defective</p>	<p>Connect the equipment to the compressed air</p> <p>Increase the powder output and/or total air volume on the control unit</p> <p>Clean corresponding part</p> <p>Replace or insert</p> <p>Replace</p> <p>(see above)</p> <p>Replace the motor throttle</p> <p>Replace the solenoid valve</p> <p>Send in for repair</p>

Spare parts list OptiSelect

Ordering spare parts

When ordering spare parts for powder coating equipment, please indicate the following specifications:

- Type and serial number of your powder coating equipment
- Order number, quantity and description of each spare part

Example:

- **Type** OptiFlex K manual coating equipment,
Serial number 1234 5678
- **Order no.** 203 386, 1 piece, Clamp - Ø 18/15 mm

When ordering cable or hose material, the required length must also be given. The spare part numbers of this yard/meter ware is always marked with an *.

The wear parts are always marked with a #.

All dimensions of plastic hoses are specified with the external and internal diameter:

Example:

Ø 8/6 mm, 8 mm outside diameter (o/d) / 6 mm inside diameter (i/d)



WARNING!

Only original ITW Gema spare parts should be used, because the hazardous location approval will be preserved that way! The use of spare parts from other manufacturers will invalidate the ITW Gema guarantee conditions!

OptiSelect manual powder gun - spare parts list

Remarks

1. If a part of the gun body should be broken, or the high voltage cascade in the gun body should be defective, then the whole gun body is to be sent in for repair and check!
2. If the powder gun cable is defective, it is to be completely sent in for repair!

A	OptiSelect manual powder gun - complete negative polarity , incl. gun cable - 6 m, rinsing air hose - 6 m, flat jet nozzle, brush and parts kit, without powder hose	1002 100
	OptiSelect manual powder gun - complete positive polarity , incl. gun cable - 6 m, rinsing air hose - 6 m, flat jet nozzle, brush and parts kit, without powder hose	1002 101
B	OptiSelect manual powder gun shaft (incl. cascade)	
	Negative polarity (-)	1001 891
	Positive polarity (+)	1001 892
C	Cascade (negative polarity) - complete	1000 809
	Cascade (positive polarity) - complete	1002 031
1	Gun body	1001 155
	Handle - complete set (pos. 5, 6, 7 and 8)	1000 807
2	Trigger - complete (incl. pos. 2 and 3)	1001 341
3	Compression spring - 0.36x4.2x49.4 mm	1001 487
4	Trigger cover	1000 801
5	Grasp termination	1000 806
6	Radial gasket	1000 803
7	Gun cable - L=6 m, complete	1001 528
	Extension cable for gun cable - L=6m, incl. safety clamp	1002 161
	Extension cable for gun cable - L=14m, incl. safety clamp	1002 162
	Safety clamp for extension cable	1002 064
8	Grub screw - M3x8 mm	1000 844
10	Powder tube - complete	1001 339
10.2	O-ring - Ø 12x1.5 mm	1000 822
11	Rinsing air connection	1000 804
12	Clip ring	1000 898
13	Compression spring	1001 488

OptiSelect manual powder gun - spare parts list

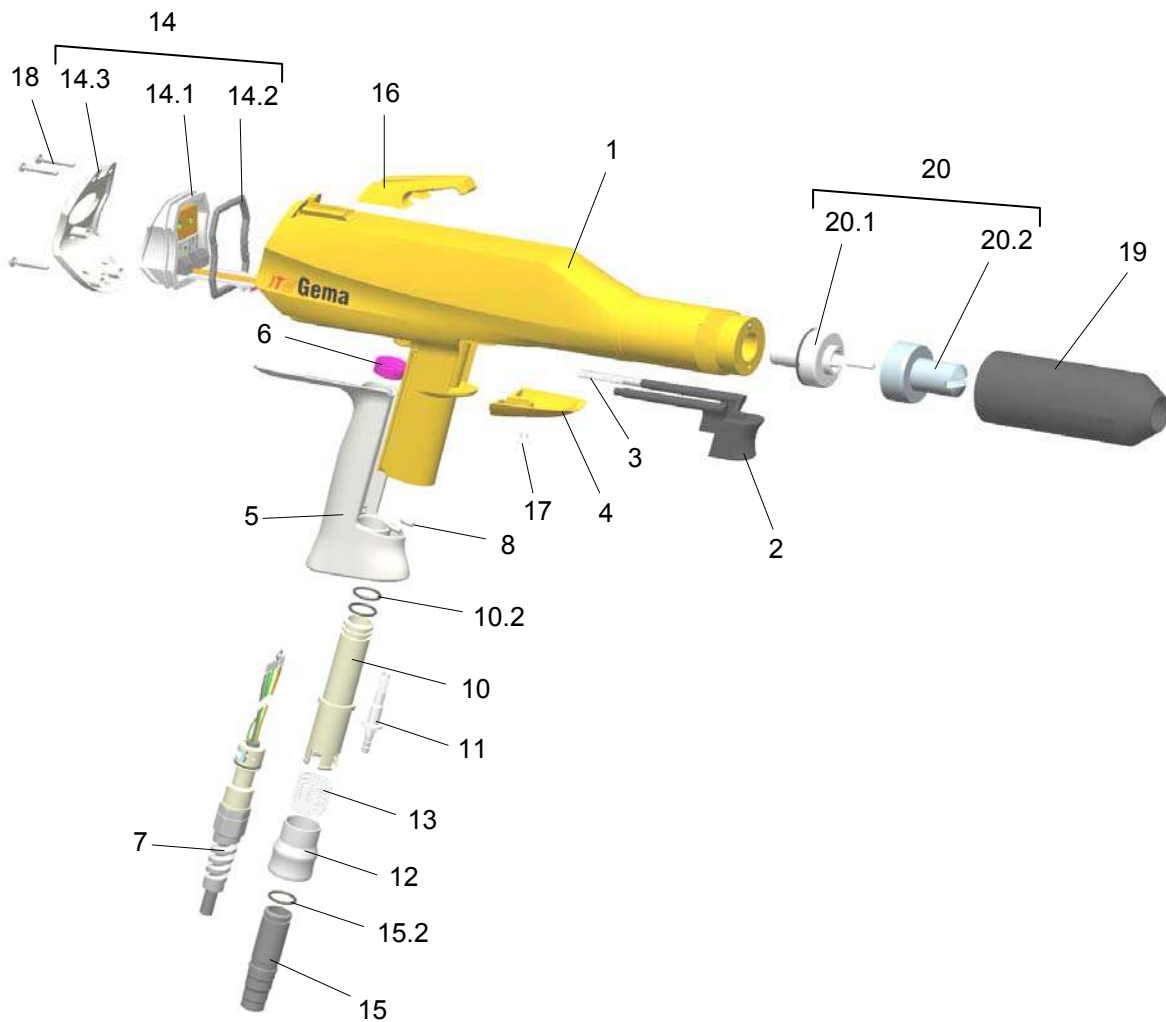









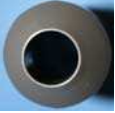

OptiSelect manual powder gun - spare parts

OptiSelect manual powder gun - spare parts list (cont.)

14	Back cover - complete	1000 617
14.1	Printed circuit board holder - complete (incl. pos. 14.2)	1002 029
14.2	Radial gasket	1000 795
14.3	Shield - complete	1002 028
14.4	Cap screw - M3x8 mm (not shown)	202 363
15	Hose connection - complete, for internal hose Ø 11-12 mm	1001 340
	Hose connection - complete, for internal hose Ø 9-10 mm	1002 030
15.2	O-ring - Ø 12x1.5 mm	1000 822
16	Hook (replaceable)	1000 877
17	Countersunk head screw - M4x8 mm, plastic	263 516
18	PT-screw	1000 843
19	Threaded sleeve - complete	1000 948
20	Flat jet nozzle - complete	1000 047
20.1	Electrode holder - complete	1000 055
20.2	Flat jet nozzle	1000 049
	OptiSelect adaptor for PGC control unit (not shown)	1001 952
	Cleaning brush - Ø 12mm	389 765
	Parts set (not shown), consisting of:	1002 359
	Round jet nozzle - NS02, complete	382 922
	Cable clamp	303 070
	Deflector plate - Ø 16 mm	331 341
	Deflector plate - Ø 24 mm	331 333
	Deflector plate - Ø 32 mm	331 325
	Hose connection - complete, for internal hose Ø 11-12 mm	1001 340
	O-ring - Ø 12x1.5 mm	1000 822
	Countersunk head screw - M4x8 mm, plastic	263 516
	Powder hose - Ø 10 mm (not shown)	1001 673
	Powder hose - Ø 11 mm (not shown)	105 139

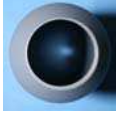



OptiSelect manual powder gun - accessories

OptiSelect flat jet nozzles - overview











Application	A	B	A + B	Threaded sleeves	Multispray-Adapter	
Profiles (Standard nozzle)	 NF08 1000 049	 1000 055	NF08 1000 047	 1000 948	 1003 634*	
	 NF09* 1000 118		NF09 1000 119			
 NF11 1000 122	NF11 1000 123					
For recess open-ings and cavities (deep)	 NF12 1000 124		NF12 1000 125	NF10 1000 121	 383 074	 1003 897*
	 NF10 1000 120					
Angled spray pat-tern (Boron Nitride)	 NF16-M* 1003 182					
Wide flat spray for large surface areas						
Flat jet nozzle for metallic powders						

* not type approved (ATEX)



OptiSelect round jet nozzles - overview

For large flat surface areas		NS02 378 518		382 914		NS02 382 922		Deflectors
						1000 948		Ø 16 mm 331 341
								Ø 24 mm 331 333
								Ø 32 mm 331 325
								Ø 50 mm 345 822



OptiSelect gun extensions and SuperCorona

		Gun extensions		SuperCorona	
	L = 150 mm	L = 300 mm	L = 150 mm	L = 300 mm	
Ø 40 mm	 378 852	 378 860	 1002 067	 1002 068	 394 203
	 396 940	 396 958	 1003 519	 1003 520	
Ø 25 mm Flat spray		 396 931			 1001 466
Ø 25 mm Deflector					







Powder hoses - overview

Powder hose	Application	Diameter	Part no.	Material	Type	Remarks
 <p> \varnothing 12/ 18 mm Typ 75 Material POE </p> <p> \varnothing 11/ 16 mm Typ 66 Material POE </p> <p> \varnothing 10/ 15 mm Typ 74 Material POE </p>	Fast color change (standard)	\varnothing 11/16 mm	105 139	POE	66	antistatic
	Fast color change - low powder flow	\varnothing 10/15 mm	1001 673	POE	74	antistatic
	Fast color change - high powder flow	\varnothing 12/18 mm	1001 674	POE	75	antistatic
 <p> \varnothing 11/ 16 mm Typ 1001 Material PUR </p> <p> \varnothing 9.5 / 12.5 mm Typ 1008 Material PUR </p>	Boron Nitride powder - low powder flow	\varnothing 9.5/12.5 mm	103 705	PUR	1008	special applications
	Used on previous equipment	\varnothing 11/16 mm	103 012	PUR	1001	special applications
 <p> \varnothing 11/ 16 mm Typ 1004 Material PVC </p>	Enamel powder	\varnothing 11/16 mm	103 128	PVC	1004	flexible powder hose
	Used on previous equipment	\varnothing 12/20 mm	100 080	PVC	1005	flexible powder hose

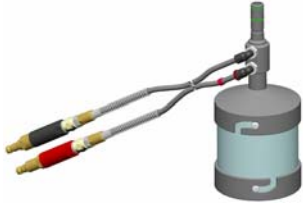
Powder hose connectors - overview

Powder hose connector	Application	Part no.	Remarks
	Hose connector for 9-10 mm hoses	1002 030	O-ring is included
	Hose connector for 11-12 mm hoses	1001 340	O-ring is included

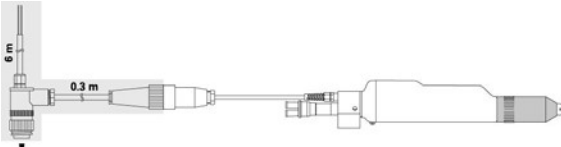
Miscellaneous parts

<p>Application cup</p>	<p>150 ml</p>  <p>1004 552</p>	<p>500 ml</p>  <p>1002 069</p>	<p>Adapter for EasySelect gun</p>  <p>1004 564</p>
<p>PGC Adapter</p>	<p>PGC Gun control ←  → OptiSelect gun</p> <p>1001 952</p>		
<p>Tribo-Corona Adapter</p>	 <p>1001 869</p>		
<p>Trigger adapter for automatic Guns</p>	 <p>OptiStar 1002 772</p>		
<p>Gun extension cable</p>	 <p>L=6 m 1002 161 L=14 m 1002 162</p>		
<p>Gloves, antistatic (1 pair)</p>	 <p>800 254</p>		

OptiFlow (IG02 type)

Principle of the injector and influence of supplementary air

If air flows through the nozzle into the cavity, a vacuum is created in the cavity (see figure below). This vacuum causes powder to be drawn up the suction tube and into the cavity. A powder/air mixture is created. The forward air velocity at the nozzle conveys the powder/air mixture through to the powder hose to the gun.

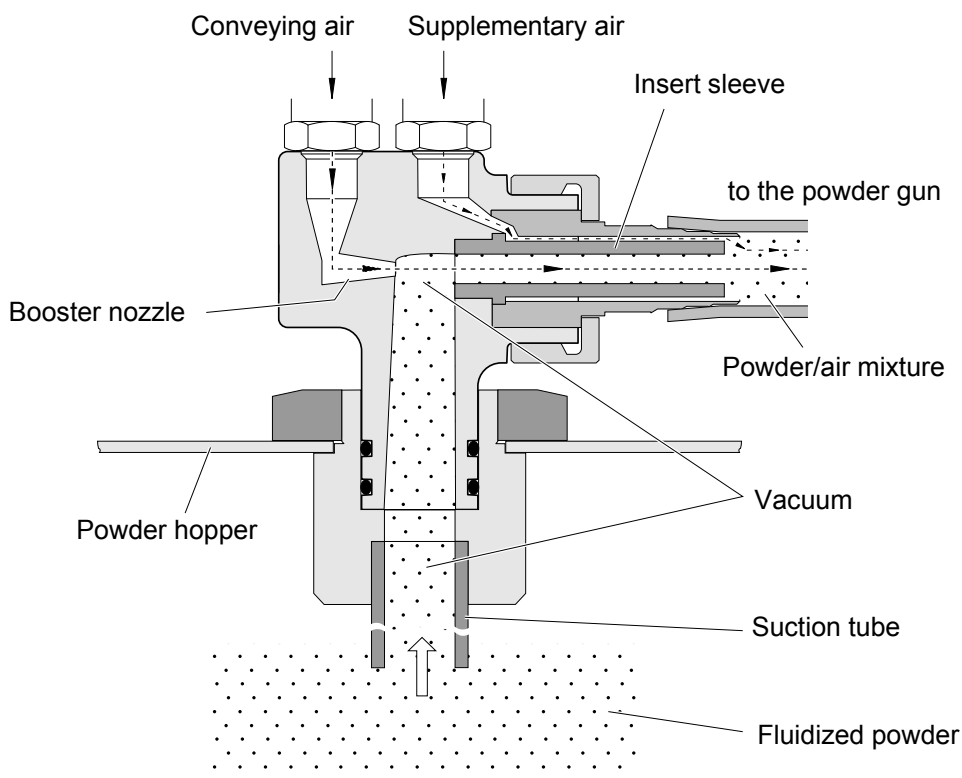

The concentration of the powder/air mixture, and with it, the powder output depends on the conveying air pressure and supplementary air pressure, the quality of the powder, the length of the powder hose, the diameter of the powder hose, the number of coils in the hose, the difference in the height between the gun and injector, and the type of nozzle. The

condition of the insert sleeve is of great importance, because wear causes the powder output to sink drastically.

Experience with pneumatic material handling technology shows that pneumatic transport of fine solid matter (powder) in the form of tubing (hose) the transporting medium requires a certain volume of air per unit of time. If a Ø 11 mm hose is used, this value is approximately 4 m³/h. To decrease the powder output, the vacuum in the cavity has to be reduced. For that purpose, the pressure of the conveying air is also reduced. With the reduction of the conveying air the volume of air in the powder hose sinks to below the optimum value of 4 m³/h. The powder transport becomes irregular, so-called "pumping" takes place. In order to prevent this from happening supplementary air is added until the volume of the air in the powder hose is 4-5 m³/h once more. This takes place fully automatically with the OptiTronic control unit.

Powder volume setting table for OptiFlow injector

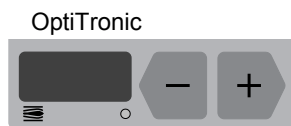
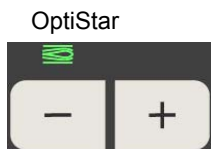

In order to set the ideal powder volume on the OptiStar/OptiTronic, it is recommended to select the firmness of the powder cloud or the total air first. As a guide value for different powder hoses, the following values can be assumed:

- Powder hose 1004, internal Ø 11 mm, **4-5 m³/h**
- Powder hose 1005, internal Ø 12 mm, **5-6 m³/h**

According to the prevailing conditions (powder, powder hose layout, the parts to be coated) a low to lowest total air can also be set with the standard hose 1004 Ø 11 mm.

If a very large powder output is required, it is recommended to select a larger powder hose inside diameter (12 mm i/d).



Note:

It should be considered, that by irregular or pumping conveying, normally the total air is set too low!

General conditions for the OptiFlow injector

Powder type	Epoxy/Polyester
Powder hose length (m)	10
Powder hose Ø (mm)	11
Input pressure (bar)	5.0
Conveying air nozzle Ø (mm)	1.6
Supplementary air nozzle Ø (mm)	1.4

Guide values for OptiStar/OptiTronic with OptiFlow injector

All values in these tables are guide values. Differing environmental conditions, wear and different powder types can change the table values.

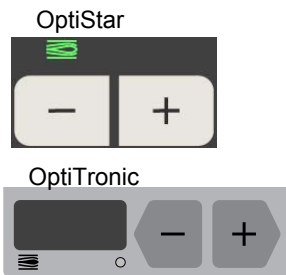

Total air		4 Nm ³ /h	5 Nm ³ /h	6 N ³ /h
		Powder output (g/min)		
Powder output (%)	10	30	35	45
	20	60	75	90
	30	85	100	120
	40	110	130	150
	50	130	160	175
	60	150	180	210
	70	175	200	235
	80	200	240	270
	90	215	260	
	100	235	290	

Cleaning and maintenance

Injector cleaning

Cleaning should be done daily before starting work or at color change:

1. Remove the injector from the hopper
2. Pull powder hose off the hose fitting (4)
3. Clean the hose fitting (4) with compressed air which is free of water and oil and check for wear
4. Clean injector body (1) with compressed air which is free of water and oil. Any contamination can be seen through the opening of the powder hopper fitting (2)
5. Reassemble the injector and fit it on the hopper



Attention:

If the injector is severely contaminated, it must be dismantled! Remove the check valves (6 and 7) with the correct sized spanner. Clean the parts with compressed air and, if necessary, dissolve sintered deposits with nitro-thinners! Don't use acetone, don't scrape!

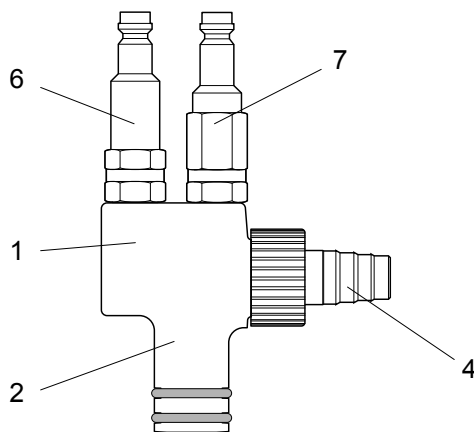

- | | | | |
|---|--------------------------|---|---------------------------------|
| 1 | Injector body | 6 | Check valve (conveying air) |
| 2 | Powder hopper connection | 7 | Check valve (supplementary air) |
| 4 | Powder hose connection | | |

Cleaning the check valves



Note:

Take care by dismantling the check valve, because the ball/spring can easily be lost!

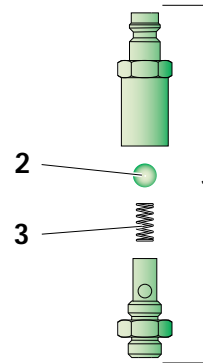

- 1 Check valve
- 2 Ball
- 3 Spring



Note:

Do not immerse the ball in solvent!

The OptiFlow injector should be cleaned once daily as a minimum! Normally, it is sufficient to clean as described on the previous page.

The injector should be dismantled completely once a week or in the case of heavy contamination (see also the figure in the spare parts list).

Troubleshooting guide

Problem fixing

The injector could be dirty or clogged, if the powder gun does not spray powder in spite of the control unit being switched on.

Error/cause	Repair
Injector nozzle, check valve, powder hose or powder gun are clogged	Clean corresponding part, if necessary replace
Too little conveying vacuum	Increase the powder volume and/or total air volume on the control unit
Insert sleeve worn or not inserted	Replace or fit the insert nozzle

Spare parts list OptiFlow

Ordering spare parts

When ordering spare parts for powder coating equipment, please indicate the following specifications:

- Type and serial number of your powder coating equipment
- Order number, quantity and description of each spare part

Example:

- **Type** OptiFlex K manual coating equipment
Serial number 1234 5678
- **Order no.** 203 386, 1 piece, Clamp - Ø 18/15 mm

When ordering cable or hose material, the required length must also be given. The spare part numbers of this yard/meter ware is always marked with an *.

The wear parts are always marked with a #.

All dimensions of plastic hoses are specified with the external and internal diameter:

Example:

Ø 8/6 mm, 8 mm outside diameter (o/d) / 6 mm inside diameter (i/d)



WARNING!

Only original ITW Gema spare parts should be used, because the explosion protection will also be preserved that way. The use of spare parts from other manufacturers will invalidate the ITW Gema guarantee conditions!

OptiFlow powder injector (IG02 type) - spare parts list

OptiFlow powder injector (complete, pos. 1-9)		391 530
1	Injector body (without pos. 2)	1000 132
2	O-ring - Ø 16x2 mm	231 517#
3	Insert sleeve - PTFE	377 724#
4	Hose connection (complete, incl. pos. 4.1)	387 827
4.1	O-ring - Ø 15x1 mm	266 930#
5	Threaded sleeve	387 819
6	Check valve conveying air (red marking) - complete (incl. pos. 8 and 9)	261 211
7	Check valve supplementary air (black marking) - complete (incl. pos. 8 and 9)	261 203
8	Ball	240 168
9	Spring	240 176
14	Quick release coupling red for conveying air hose - Ø 8/6 mm	261 645
15	Quick release coupling for supplementary air hose - Ø 8/6 mm	261 637
16	Conveying air hose - Ø 8/6 mm (red)	103 500*
17	Supplementary air hose - Ø 8/6 mm (black)	103 756*
18	Quick release coupling for hose - Ø 8/6 mm	203 181
	Powder hose - type 1001, PUR, Ø 16/11 mm (standard for automatic guns)	103 012*#
	Powder hose - type 1004, PVC, Ø 16/11 mm (standard for manual equipment)	103 128*#
	Powder hose - type 1005, PVC, Ø 20/12 mm (for manual equipment)	100 080*#
	Powder hose - type 66, POE, Ø 16/11 mm, with conductive strip (for automatic guns)	105 139*#
	Powder hose - type 74, POE, Ø 15/10 mm, with conductive strip (for automatic guns)	1001 673*#
	Powder hose - type 75, POE, Ø 18/12 mm, with conductive strip (for automatic guns)	1001 674*#

Wearing part

* Please indicate length

OptiFlow powder injector (IG02 type) - spare parts

Automatic equipment

Manual equipment

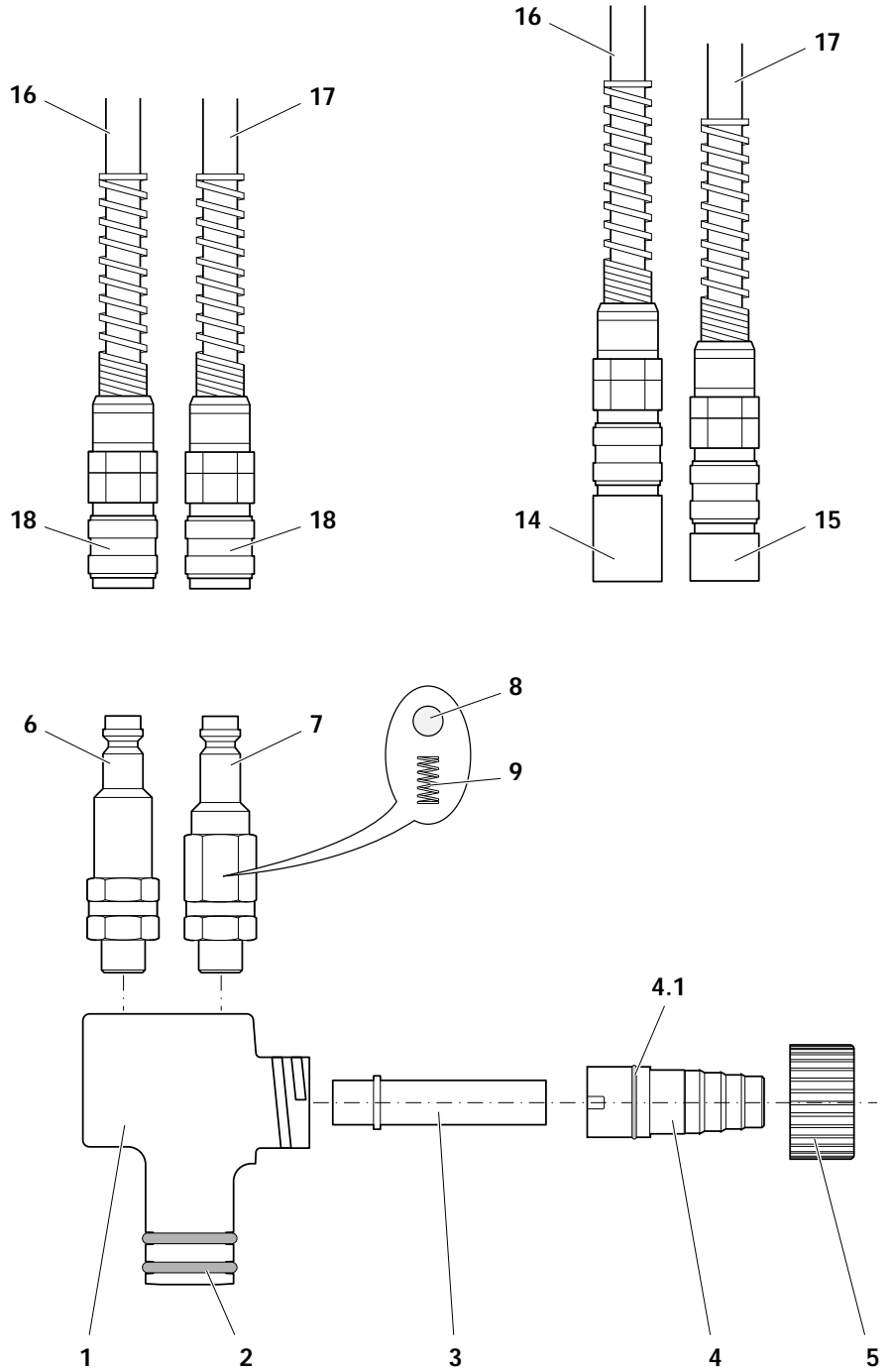

OptiFlow powder injector (IG02 type) - spare parts