

---

Operating instructions and Spare parts list

# Robot gun

## RobotGun GM03-R



Translation of the original operating instructions

**Documentation RobotGun GM03-R**

© Copyright 2017 Gema Switzerland GmbH

All rights reserved.

This publication is protected by copyright. Unauthorized copying is prohibited by law. No part of this publication may be reproduced, photocopied, translated, stored on a retrieval system or transmitted in any form or by any means for any purpose, neither as a whole nor partially, without the express written consent of Gema Switzerland GmbH.

Gema, EquiFlow, MagicCompact, MagicCylinder, OptiCenter, OptiFlex, OptiGun, OptiSelect and OptiStar are registered trademarks of Gema Switzerland GmbH.

ClassicLine, ClassicStandard, ClassicOpen, DVC (Digital Valve Control), GemaConnect, MagicControl, MagicPlus, MonoCyclone, MRS, MultiColor, MultiStar, OptiAir, OptiControl, OptiColor, OptiFeed, OptiFlow, OptiHopper, OptiMove, OptiSieve, OptiSpeeder, OptiSpray, PCC (Precise Charge Control), RobotGun, SIT (Smart Inline Technology) und SuperCorona are trademarks of Gema Switzerland GmbH.

All other product names are trademarks or registered trademarks of their respective holders.

Reference is made in this manual to different trademarks or registered trademarks. Such references do not mean that the manufacturers concerned approve of or are bound in any form by this manual. We have endeavored to retain the preferred spelling of the trademarks, and registered trademarks of the copyright holders.

To the best of our knowledge and belief, the information contained in this publication was correct and valid on the date of publication. Gema Switzerland GmbH makes no representations or warranties with respect to the contents or use of this publication, and reserves the right to revise this publication and make changes to its content without prior notice.

For the latest information about Gema products, visit  
**[www.gemapowdercoating.com](http://www.gemapowdercoating.com)**.

For patent information, see **[www.gemapowdercoating.com/patents](http://www.gemapowdercoating.com/patents)** or  
**[www.gemapowdercoating.us/patents](http://www.gemapowdercoating.us/patents)**.

**Printed in Switzerland**

Gema Switzerland GmbH  
Mövenstrasse 17  
9015 St.Gallen  
Switzerland

Phone: +41-71-313 83 00

Fax.: +41-71-313 83 83

E-mail: [info@gema.eu.com](mailto:info@gema.eu.com)

# Table of contents

<b>About these instructions</b>	<b>5</b>
General information .....	5
Keeping the Manual .....	5
Safety symbols (pictograms).....	5
Structure of Safety Notes.....	6
Presentation of the contents .....	6
Figure references in the text .....	6
<b>Safety</b>	<b>7</b>
Basic safety instructions .....	7
Product specific security regulations .....	7
<b>Product description</b>	<b>9</b>
Intended use .....	9
A summary of the directives and standards.....	10
Reasonably foreseeable misuse.....	11
Technical Data .....	11
Versions .....	11
Fitting the gun .....	12
Electrical data .....	12
Dimensions .....	12
Processable powders.....	13
Structure.....	14
Overall view.....	14
Scope of delivery .....	14
Available accessories** .....	15
SuperCorona ring.....	16
Principle of function.....	17
High voltage generation .....	17
Powder flow and electrode rinsing air .....	17
Flat jet nozzle with vented central electrode.....	18
Round jet nozzle with vented deflector and vented central electrode .....	18
Typical characteristics – properties of the functions .....	19
Quick assembly/disassembly.....	19
Connection for SuperCorona Ring.....	19
<b>Assembly / Connection</b>	<b>21</b>
Connecting the Gun .....	21
<b>Start-up</b>	<b>23</b>
Preparation for start-up .....	23
Basic conditions .....	23
Initial start-up.....	24
<b>Operation</b>	<b>25</b>
Operation .....	25

Setting powder output and powder cloud .....	25
Setting the electrode rinsing air .....	26
<b>Decommissioning / Storage</b>	<b>29</b>
Shutdown .....	29
If in disuse for several days .....	29
Storage conditions .....	29
Hazard notes .....	29
Type of storage .....	29
Storage duration .....	29
Space requirements .....	29
Physical requirements .....	30
Maintenance during storage .....	30
Maintenance schedule .....	30
Maintenance works .....	30
<b>Maintenance / Repairs</b>	<b>31</b>
Interval .....	31
Gun maintenance .....	31
Cleaning .....	31
Gun cleaning .....	31
Cleaning the spray nozzle .....	32
Replacing parts .....	33
<b>Fault clearance</b>	<b>35</b>
<b>Disposal</b>	<b>37</b>
Introduction .....	37
Requirements on personnel carrying out the work .....	37
Disposal regulations .....	37
Materials .....	37
<b>Spare parts list</b>	<b>39</b>
Ordering spare parts .....	39
RobotGun GM03-R– Spare parts list .....	40
RobotGun GM03-R – Spare Parts .....	41
Gun Body - Spare Parts List .....	42
Gun Body – Spare Parts .....	43
SuperCorona .....	44
Accessories .....	45
Flat jet nozzle – Overview (wearing parts) .....	45
Round jet nozzle – Overview (wearing parts) .....	46
Gun extensions .....	46
Spray nozzles for extensions – overview (wearing parts) .....	47
Diffusor– Spare parts list .....	48

# About these instructions

---

## General information

This operating manual contains all the important information which you require for the working with the RobotGun GM03-R. It will safely guide you through the start-up process and give you references and tips for the optimal use when working with your powder coating system.

Information about the functional mode of the individual system components should be referenced in the respective enclosed documents.

---

## Keeping the Manual

Please keep this Manual ready for later use or if there should be any queries.

---

## Safety symbols (pictograms)

The following warnings with their meanings can be found in the Gema instructions. The general safety precautions must also be followed as well as the regulations in the relevant instructions.

### DANGER

Indicates a hazardous situation which, if not avoided, will result in death or serious injury.

---

### WARNING

Indicates a hazardous situation which, if not avoided, could result in death or serious injury.

---

### CAUTION

Indicates a hazardous situation which, if not avoided, could result in minor or moderate injury.

---

### ATTENTION

Indicates a potentially harmful situation. If not avoided, the equipment or something in its surrounding may be damaged.

---

**ENVIRONMENT**

Indicates a potentially harmful situation which, if not avoided, may have harmful consequences for the environment.

**MANDATORY NOTE**

Information which must be observed.

**NOTICE**

Useful information, tips, etc.

**Structure of Safety Notes**

Every note consists of 4 elements:

- Signal word
- Nature and source of the danger
- Possible consequences of the danger
- Prevention of the danger

**⚠ SIGNAL WORD**

**Nature and source of the hazard!**

**Possible consequences of the danger**

- ▶ Prevention of the danger

---

## Presentation of the contents

**Figure references in the text**

Figure references are used as cross references in the descriptive text.

**Example:**

*"The high voltage (**H**) created in the gun cascade is guided through the center electrode."*

# Safety

---

## Basic safety instructions

- This product is built to the latest specification and conforms to the recognized technical safety regulations and is designed for the normal application of powder coating.
- Any other use is considered non-compliant. The manufacturer shall not be liable for damage resulting from such use; the user bears sole responsibility for such actions. If this product is to be used for other purposes or other substances outside of our guidelines then Gema Switzerland GmbH should be consulted.
- Start-up (i.e. the execution of intended operational tasks) is forbidden until it has been established that this product has been set up and wired according to the guidelines for machinery. The standard "Machine safety" must also be observed.
- Unauthorized modifications to the product exempt the manufacturer from any liability from resulting damage.
- The relevant accident prevention regulations, as well as other generally recognized safety regulations, occupational health and structural regulations are to be observed.
- Furthermore, the country-specific safety regulations also must be observed.

---

## Product specific security regulations

- This product is a constituent part of the equipment and is therefore integrated in the system's safety concept.
- If it is to be used in a manner outside the scope of the safety concept, then corresponding measures must be taken.
- The installation work to be done by the customer must be carried out according to local regulations.
- It must be ensured, that all components are earthed according to the local regulations before start-up.



---

**For further security information, see the more detailed Gema safety regulations!**

---

**⚠ WARNING****Working without instructions**

**Working without instructions or with individual pages from the instructions may result in damage to property and personal injury if relevant safety information is not observed.**

- ▶ Before working with the device, organize the required documents and read the section "Safety regulations".
- ▶ Work should only be carried out in accordance with the instructions of the relevant documents.
- ▶ Always work with the complete original document.



# Product description

---

## Intended use

This gun is used for electrostatic coating of objects connectable to ground with organic powders in conjunction with the control units and accessories, as specified in the corresponding type examination certificate.

The gun will also operate in combination with the AP01 application pump or other Gema models with a suitable diffuser (spraying air adapter). Please contact Gema if you have any further queries.



*Fig. 1*

Observance of the operating, service and maintenance instructions specified by the manufacturer is also part of conformity of use. This product should only be used, maintained and started up by trained personnel, who are informed about and are familiar with the possible hazards involved.

Any other use is considered non-compliant. The manufacturer is not responsible for any incorrect use and the risks associated with such actions are assumed by the user alone!

## A summary of the directives and standards

This product was built according to the current state of the art. The product is subject to the European directives and complies with the following standards.

The product is suitable for the intended purpose and can be used in the appropriate areas.



**For further information, also refer to the enclosed Declaration of Conformity.**

### *European directives RL*

<b>EG-RL 2006/42/EU</b>	Machinery
<b>EG-RL 2014/34/EU</b>	Equipment and Protective Systems in Potentially Explosive Atmospheres (ATEX)
<b>EG-RL 2014/30/EU</b>	Electromagnetic compatibility

### *EN European standards*

<b>EN 50177</b>	Stationary electrostatic application equipment for ignitable liquid coating material - Safety requirements
<b>EN 50050-2</b>	Electrostatic equipment for areas where there is danger of explosion - electrostatic hand held equipment Part 2: Electrostatic hand-held spraying equipment
<b>EN 16985</b>	Spray booths for organic coating material - Safety requirements

### *Recognized safety-related regulations*

<b>764 / DGUV Information 209-052</b>	Electrostatic coating Trade Union information concerning health and safety during work (BGI)
---	---

### Reasonably foreseeable misuse

- Use with insufficient compressed air quality
- Input pressure too low

---

## Technical Data

### Versions

Depending on the operational area, the robot gun is available in four versions with different connecting flanges:

---

**GM03-R Single**



**GM03-R Single Quick**



---

**GM03-R Dual**



**GM03-R Dual Quick**



## Fitting the gun

An adaptor piece (A) is required for fitting the gun (Quick) on the robot.

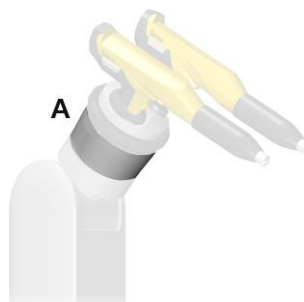

Fig. 2: Robot adaptor piece



The adaptor piece depends on the robot specifications and is manufactured by Gema after consultation with the customer.

## Electrical data

RobotGun GM03-R	
Nominal input voltage	eff. 10 V
Frequency	18 kHz (average)
Nominal output voltage	100 kV
Polarity	Negative (optional positive)
Max. output current	100 µA
Ignition protection	Ex 2 mJ T6
Temperature range	0 °C - +40 °C (+32 °F - +104 °F)
Max. surface temperature	85 °C (+185 °F)
Protection type	IP64
Approvals	0102  II 2D PTB 11 ATEX 5006

## Dimensions

RobotGun GM03-R	Single	Single Quick	Dual	Dual Quick
Weight	640 g	760 g	1180 g	1380 g

## Processable powders

RobotGun GM03-R	
Plastic powder	yes
Metallic powder	yes
Enamel powder	no

## Structure

### Overall view

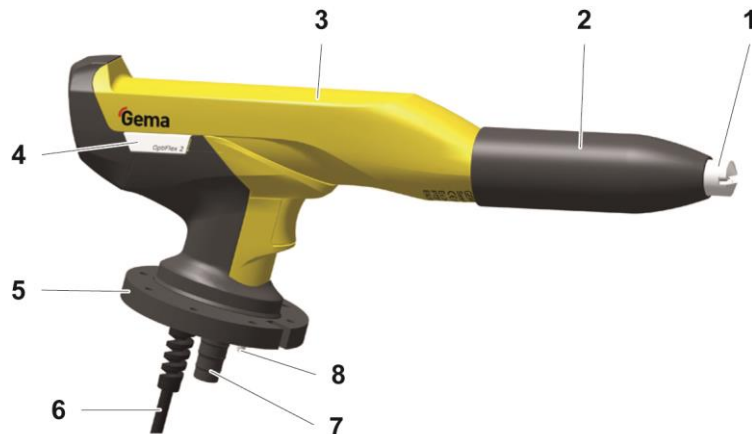

Fig. 3

- |   |                        |   |                                  |
|---|------------------------|---|----------------------------------|
| 1 | Spray nozzle system    | 5 | Flange                           |
| 2 | Threaded sleeve        | 6 | Gun cable                        |
| 3 | Shaft                  | 7 | Powder hose connection           |
| 4 | SuperCorona connection | 8 | Electrode rinsing air connection |

## Scope of delivery

- Robot gun with gun cable (20 m), negative polarity
- Powder hose (20 m, ID 11 mm)
- Rinsing air hose (20 m)
- Flat jet nozzle NF27, complete (incl. electrode holder)
- Cable tie with Velcro closure
- Gun cleaning brush
- Spare parts kit
- Operating manual

---

## Available accessories\*\*

- SuperCorona ring
- Flat jet nozzle (for specific applications)
- Round jet nozzles
- Gun extension 150 and 300 mm
- Gun cable extensions
- Various adapters for connection to earlier generations of control units

\*\*for more information, see spare parts list

## SuperCorona ring

### *Field of application*

The SuperCorona is an optional extension for the gun, allowing for a better surface quality when coating with the powder coating equipment.

When coating wheel rims, drawers, radiators, lamps etc. the surface quality is exceptional, also in places with higher coating layer requirements. By coating with several powder types, an "orange peel" finish can be completely avoided. By coating with structure powder, the "picture frame effect" is hardly visible.

The gun with SuperCorona is convincing due to its very good charging and very high deposition rate as well as an improved penetration into Faraday cages. The distance between nozzle and workpiece can be reduced to 100 mm without influencing the surface finish.

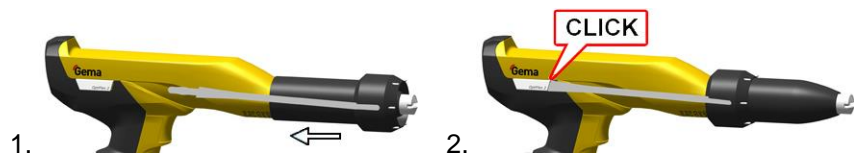

Fig. 4

Due to its modular structure, the gun can be fast and easily extended with the light SuperCorona (approx. 60 g). The gun remains repair-friendly and easy to maintain even after reconfiguration.

### *SuperCorona assembly*

Before fitting the SuperCorona ring, make sure that the connection and the plug-in connector are free from grease and powder, otherwise the electric contact cannot be guaranteed.





## Principle of function

### High voltage generation

The control unit supplies a high-frequency low voltage signal of approx. 10 V eff. This voltage is fed through the gun cable (1) to the high voltage cascade (2) in the gun shaft.

In the high voltage cascade (2), the low voltage is high-transformed in a first step (c). This primary high voltage is subsequently rectified and multiplied in the high voltage cascade in a second step (d), until the required high voltage is obtained at the end (approx. 100 kV). The high voltage is now fed to the electrode (E) within the spray nozzle.

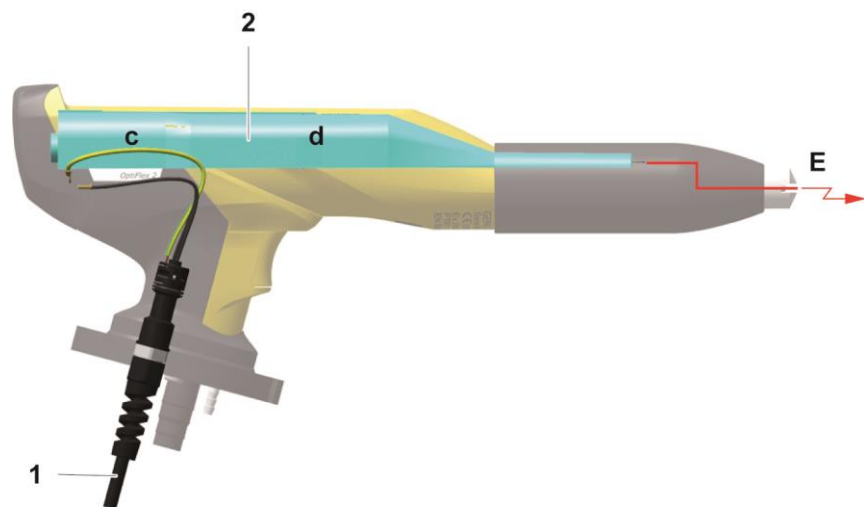

Fig. 5

### Powder flow and electrode rinsing air

The electrode rinsing air is used by vented spray nozzles and is connected with its designated connection on the rear side of the gun control unit (see the operating manual of the gun control unit). The functions of the spray nozzles are described in the corresponding section of this manual.

### Flat jet nozzle with vented central electrode

The vented flat jet nozzle serves for the spraying and the charging of the powder. The powder is charged by the central electrode (E). The high voltage (H) created in the gun cascade is guided through the center electrode.

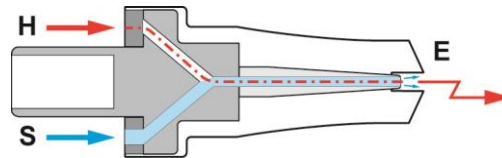

Fig. 6

In order to prevent powder from sintering on the electrode, compressed air is used during the spray process.

The rinsing air (S) adjustment on the gun control unit is described in the corresponding operating manual.

### Round jet nozzle with vented deflector and vented central electrode

The vented deflector is used, to give the powder stream emerging from the gun, a cloud formation. The powder is charged by the central electrode (E). The high voltage (H) created in the gun cascade is guided through the center electrode.

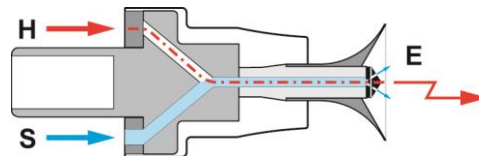

fig. 7

Since powder can accumulate on the baffle plate, it must be rinsed with compressed air.

The electrode rinsing air (S) can be adjusted on the gun control unit, depending on the gun type (see corresponding operating manual).

---

## Typical characteristics – properties of the functions

The Robot Gun with an integrated high voltage generator is particularly suitable for operation on a freely programmable robot (up to 7 axles) for coating of complex contours and object positions difficult to access.

### Quick assembly/disassembly

The Gun is characterized by its fast assembly and disassembly to the robot. Accordingly, the time requirement for maintenance or cleaning purposes can be lowered.

The gun is installed on the front side of a coating robot. An appropriate adaptor piece for the corresponding robot type is used for fitting the applicator on the robot. This adaptor provides by means of a pin for exact positioning of the gun, as well as the fixture of the gun cable and the hoses.



---

**The indexation and the flange measures can be implemented robot-specifically.**

---

### Connection for SuperCorona Ring

- Quick and simple connection and disconnection of the SuperCorona ring





# Assembly / Connection

## Connecting the Gun

The gun is delivered ready-to-use by the manufacturer. Just a few cables and hoses must be connected.



**The compressed air must be free of oil and water!**

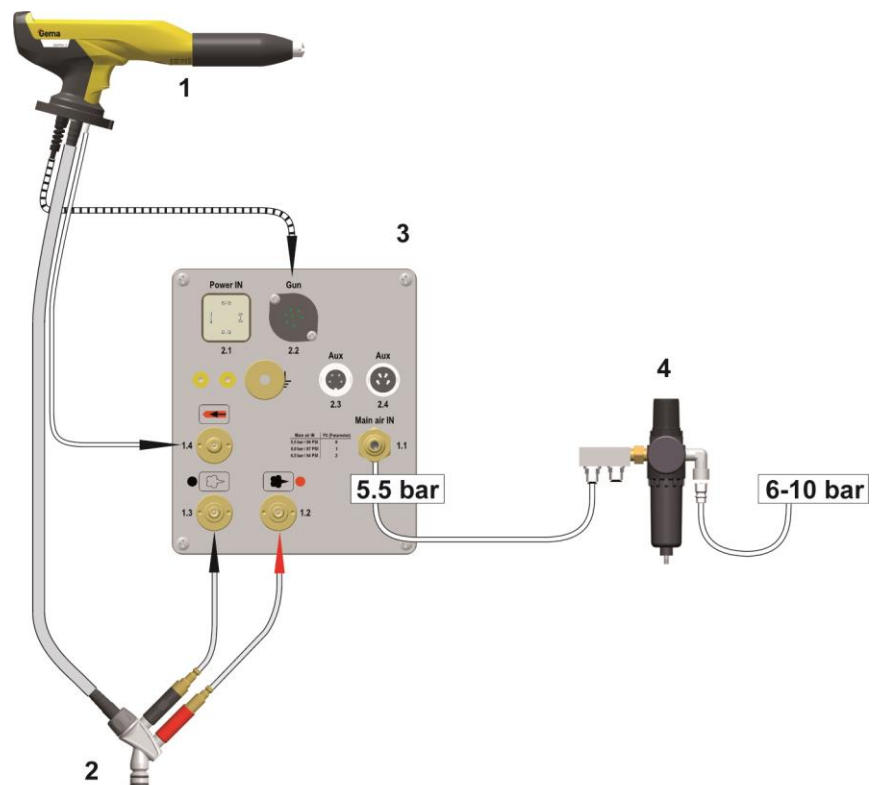

Fig. 8

- |   |          |   |                  |
|---|----------|---|------------------|
| 1 | Gun      | 3 | Gun control      |
| 2 | Injector | 4 | Maintenance unit |



# Start-up



---

The relevant safety standards, as well as the safety regulations of the robot manufacturer are absolutely to be respected for the operation of the Robot Gun!

---

---

## Preparation for start-up

### Basic conditions

When starting up the gun control unit, the following general conditions impacting the coating results must be taken into consideration:

- Gun correctly connected
- Gun control unit correctly connected
- Corresponding power and compressed air supply available
- Powder preparation and powder quality OK

## Initial start-up



If a malfunction occurs, see the troubleshooting guide, as well as the gun control unit operating manual!



Fig. 9



The remainder of the start-up procedure for the Gun is explicitly described in the operating instructions for the OptiStar CG08/CG13 powder gun control unit (chapter "Initial start-up" and "Start-up")!



# Operation

## ⚠ WARNING

### Discharges when touching the gun parts

During the coating process, the gun can discharge along the body of the coater if touching it.

- ▶ Do not touch any parts of the gun!

## Operation

### Setting powder output and powder cloud

The powder output depends on the selected powder output (in %), and the powder cloud on the selected total air volume.



**As a factory default value, a powder rate of 50% and a total air volume of 4 Nm<sup>3</sup>/h are recommended.**

- If values are entered that the gun control unit cannot implement, then the operator is informed of this by a blinking in the relevant display and a temporary error message!

### Setting the total air volume



Adjust the total air volume on the gun control unit with the **T3/T4** keys

- Adjust the total air volume according to the corresponding coating requests



*correct powder cloud*

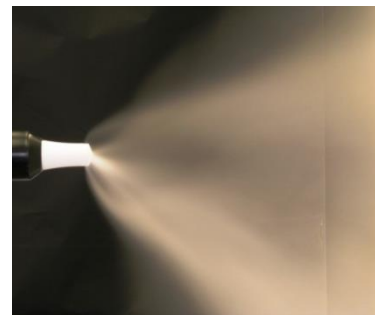

*too little total air*

### Setting the powder output



*much powder*



*little powder*

Adjust the powder output volume (e.g. according to the desired coating thickness)

- Factory default setting of 50% is recommended for initial operation. The total air volume is thereby kept constant automatically by the control unit.



**To achieve maximum efficiency, we recommend avoided an overly high powder volume where possible!**

2. Check fluidization of the powder in the powder container
3. Point the gun into the booth, switch the gun on and visually check the powder output

### Setting the electrode rinsing air

1. Press the  key.  
The second display level will be shown.



Adjust the correct electrode rinsing air according to the applied nozzles (deflector plate, flat jet nozzle)

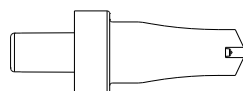

≈ 0,1 Nm<sup>3</sup>/h

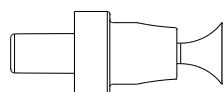

≈ 0,5 Nm<sup>3</sup>/h



*too much electrode rinsing air*

- 
- 
3. If in this display level is no operation for 3 seconds, the first display level is switched over independently.



# Decommissioning / Storage

---

## Shutdown

1. End the coating procedure
2. Switch off the control unit



---

**The adjustments for high voltage, powder output volume and electrode rinsing air remain stored.**

---

### If in disuse for several days

1. Switch off the plant with the main switch
2. Clean the gun and the components for powder conveying (see therefore the corresponding user manuals)
3. Turn off the compressed air main supply

---

## Storage conditions

### Hazard notes

There is no danger to personnel or the environment if the unit is stored properly.

### Type of storage

For safety reasons, the product should only be stored in a horizontal position

### Storage duration

If the physical conditions are maintained, the unit can be stored indefinitely.

### Space requirements

The space requirements correspond to the size of the product.

There are no special requirements concerning distance to neighboring equipment.

## Physical requirements

Storage must be inside a dry building at a temperature between +5 and +50 °C. Do not expose to direct sunlight!

---

## Maintenance during storage

### Maintenance schedule

No maintenance schedule is necessary.

### Maintenance works

During long-term storage, periodically perform a visual check.

# Maintenance / Repairs

---

## Interval

### Gun maintenance

The gun is designed to require only a minimum amount of maintenance.

1. Clean the gun with dry cloth, see chapter "Maintenance"
2. Check connection points to powder house.
3. Replace the powder hoses, if necessary.

---

## Cleaning

### ATTENTION

**Any unauthorized modifications and alterations to the product are not permitted for safety reasons and exclude the manufacturer's liability for any resulting damage!**



**Regular and conscientious cleaning and maintenance increase the service life of the product and ensure consistent high coating quality!**

- The parts to be replaced during maintenance work are available as spare parts. These parts can be found in the appropriate spare parts list!

### Gun cleaning

### ATTENTION

#### Impermissible solvents

**The following solvents may not be used to clean the gun:**

- ▶ Ethylene chloride, acetone, ethyl acetate, methyl ethyl ketone, methylene chloride, premium gasoline, turpentine, tetrachloromethane, toluene, trichloroethylene, xylene!



---

**Only cleaning agents with a flash point of a least 5 Kelvin above the ambient temperature, or cleaning places with technical ventilation are allowed!**

---



---

**Before cleaning the powder gun, switch off the control unit. The compressed air used for cleaning must be free of oil and water!**

---

***Daily:***

1. Blow off the outside of the gun and wipe, clean etc.

***Weekly:***

2. Remove powder hose
3. Remove the spray nozzle from the gun and clean it with compressed air
4. Blow through the gun with compressed air, beginning from the connection in flow direction
5. Clean the integrated gun tube with the brush supplied if necessary
6. Blow through the gun with compressed air again
7. Clean the powder hose
8. Reassemble the gun and connect it

## **Cleaning the spray nozzle**

***Daily or after every shift***

1. Clean the inside and outside of the spray nozzle with compressed air.

Never immerse the parts in solvents!

2. Check the seating of the spray nozzles.

### **ATTENTION**

**Threaded sleeve not tightened well**

**If the spray nozzle is just fitted loosely, there is danger of a flash-over of the gun high voltage, which can damage the gun!**

- ▶ Always tighten the threaded sleeve well!
- 

***Weekly:***

1. Remove the spray nozzle and clean on the inside with compressed air. If sinterings should have formed, then they have to be removed!

***Monthly***

1. Check spray nozzle for wear  
The flat jet nozzle is to be replaced, if:
  - the spray pattern is no longer a regular oval
  - deeper grooves are in the nozzle slot, or even the wall thickness is no longer recognizable



- the wedge of the electrode holder is worn

Nozzles with deflectors:

- if the wedge of the electrode holder is worn down, then the electrode holder is to be replaced

## Replacing parts

Except for the replacement of possible defective parts, there are very few repairs to be made.



---

**The replacement of the cascade and the repair of the powder gun cable connection is only permitted by an authorized Gema Service center!**

- Contact your Gema representative!
-



# Fault clearance



**Additional error descriptions are to be found also in the control unit operating instructions!**

Incident	Causes	Corrective action
<b>H11 (Help code on control unit)</b>	Gun not connected	Connect the gun
	Gun plug or gun cable defective	Contact local Gema representative
	Remote control on powder gun defective	Contact local Gema representative
<b>Powder does not adhere to object, although the gun is triggered and sprays powder</b>	High voltage and current deactivated	Check the high voltage and current setting
	High voltage cascade defective	Contact local Gema representative
	The objects are not properly grounded	Check the grounding
<b>The gun does not spray powder, although the control unit is switched on and the gun trigger is pressed</b>	Compressed air not present	Connect the equipment to the compressed air
	Injector or nozzle on the injector, powder hose or powder gun clogged	Clean the corresponding part
	Insert sleeve in the injector is clogged	Clean/replace
	Pressure valve in the control unit defective	Replace
	Solenoid valve in the control unit defective	Replace
	No conveying air: <ul style="list-style-type: none"> <li>– Throttle motor defective</li> <li>– Solenoid valve defective</li> </ul>	Contact local Gema representative
	Front plate defective	Contact local Gema representative

<b>Incident</b>	<b>Causes</b>	<b>Corrective action</b>
<b>Gun achieving only poor spray profile</b>	Total air incorrectly configured	Increase the powder quantity and/or total air volume on the control unit
	Bend or damage to air lines to injector	Check air lines to injector
	Insert sleeve in the injector worn or not inserted	Replace or insert it
	Fluidization not running	see above

# Disposal

---

## Introduction

### Requirements on personnel carrying out the work

The disposal of the product is to be carried out by the owner or operator. When disposing of components that are not manufactured by Gema, the instructions in the respective manufacturer's documentation must be observed.

### Disposal regulations



---

**The product must be disassembled and disposed of properly at the end of its service life.**

- ▶ When disposing of the product, the applicable local and regional laws, directives and environmental regulations must be complied with!
- 

### Materials

The materials must be sorted according to material groups and taken to the appropriate collection points.



# Spare parts list

---

## Ordering spare parts

When ordering spare parts for your product, please indicate the following specifications:

- Type and serial number of your product
- Order number, quantity and description of each spare part

**Example:**

- **Type** Robot gun RobotGun GM03-R  
Serial number 1234 5678
- **Order no.** 203 386, 1 piece, Clamp – Ø 18/15 mm

When ordering cable or hose material, the required length must also be given. The spare part numbers of this bulk stock is always marked with an \*.

The wearing parts are always marked with a #. marked.

All dimensions of plastic hoses are specified with the external and internal diameter:

**Example:**

Ø 8/6 mm, 8 mm outside diameter (o/d) / 6 mm inside diameter (i/d)

**⚠ WARNING**

**Use of non-original Gema spare parts**

**When using the spare parts from other manufacturers the explosion protection is no longer guaranteed. If any damage is caused by this use all guarantee claims become invalid!**

- ▶ Only original Gema spare parts should be used!
-

## RobotGun GM03-R– Spare parts list



**Only parts were included in the spare parts list, which the user can replace himself without problems!**

- ▶ If the powder gun cable is defective, it is to be completely sent in for repair!

RobotGun GM03-R - complete		
negative polarity, incl. gun cable – 20 m, flat jet nozzle, brush and parts kit, without powder hose		
	– <b>RobotGun GM03-R Single</b> – incl. Pos. 5 and 6	1013 976
	– <b>RobotGun GM03-R Single Quick</b> – incl. Pos. 5, 7 and 8	1013 981
	– <b>RobotGun GM03-R Dual</b> – incl. Pos. 5, 9 and 10	1013 988
	– <b>RobotGun GM03-R Dual Quick</b> – incl. Pos. 5, 8 and 11	1013 986
1	Gun body (incl. cascade) with:	
	Gun cable 20 m, negative polarity (–)	1013 971
	Gun cable 30 m, negative polarity (–)	1013 972
2	Flat jet nozzle NF27 – complete	1010 754#
2.1	Electrode holder – complete	1007 683#
2.2	Flat jet nozzle NF27	1010 752#
3	Threaded sleeve – complete	1007 229#
4	Gun cable 20 m – complete	1013 991
	Gun cable 30 m – complete	1013 992
5	Screw – M5x8 mm	1013 996
6	Connecting flange - Single	1013 974
7	Connecting flange - Single Quick	1013 978
8	Threaded sleeve	653 420
9	Screw – M5x16 mm	216 356
10	Connecting flange - Dual	1015 086
11	Connecting flange - Dual Quick	1013 984
	Cleaning brush – Ø 12 mm (not shown)	389 765
	<b>Parts set (not shown), consisting of:</b>	<b>1013 977</b>
	Cable clamp	303 070
	Quick release connection – NW5-Ø 6 mm	200 840
	Powder hose – Ø 11 mm (not shown)	105 139*#

\* Please indicate length

# Wearing part



# RobotGun GM03-R – Spare Parts

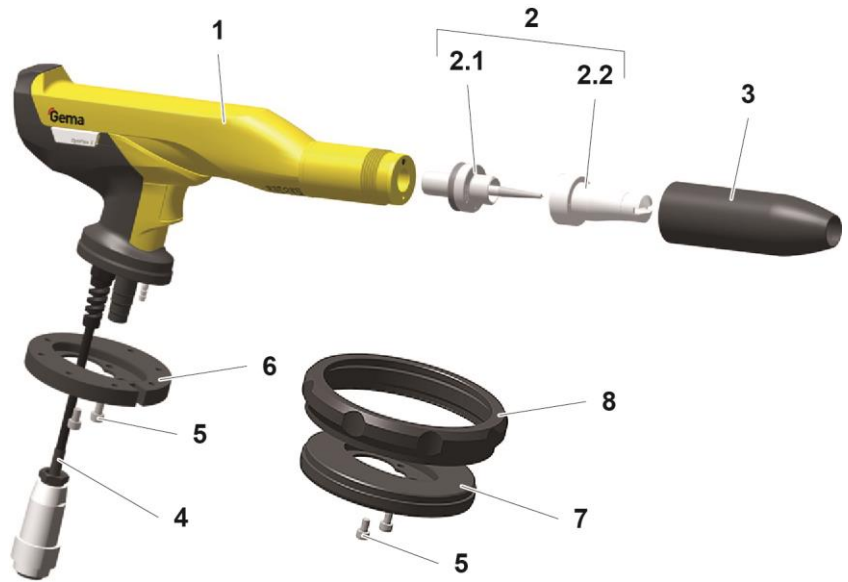

Fig. 10: RobotGun GM03-R Single (Quick)

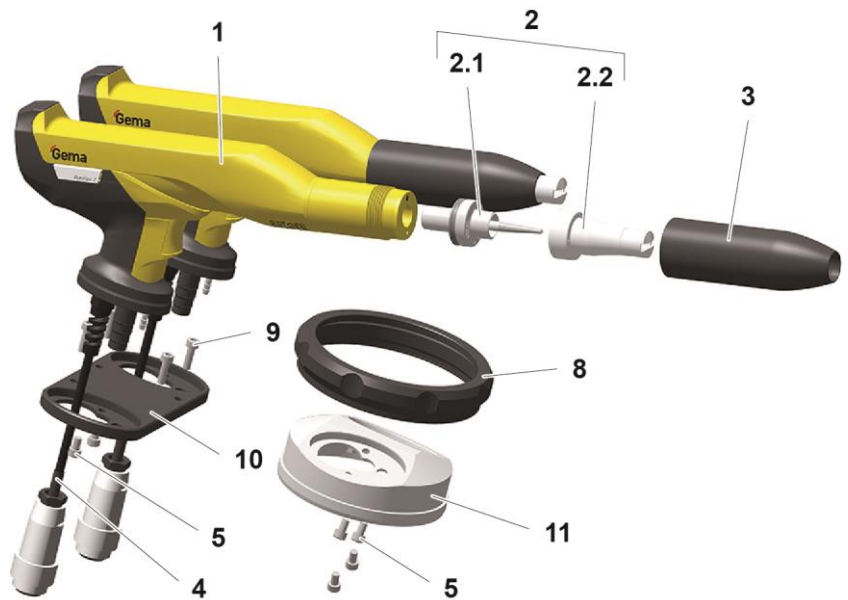

Fig. 11: RobotGun GM03-R Dual (Quick)

## Gun Body - Spare Parts List

1	Gun body – complete	1013 956
2	Cover	1013 966
3	Screw – M4x6 mm	1000 845
4	Grub screw – M3x8 mm	1008 157
5	Screw – M4x12 mm	1010 281
6	Rinsing air connection	1000 804
7	Hose connection – complete, incl. pos. 8	1013 968#
8	O-ring – Ø 12x1.5 mm, FMP75	1000 822#
9	Plate	1013 969
10	Support – complete, incl. pos. 4 and 11	1013 965
11	Gasket	1007 633
12	SuperCorona holder	1007 238
13	Lid – complete, incl. pos. 15	1013 962
14	Screw – M6x16 mm	1007 986
15	Cover	1013 963
16	Cascade space gasket - complete	1007 635#
17	Cascade – complete, negative–	1007 231
	Cascade – complete, positive +	1007 232
18	Gun cable	
	Powder hose – Ø 11 mm (not shown)	105 139*#

\* Please indicate length

# Wearing part

## Gun Body – Spare Parts

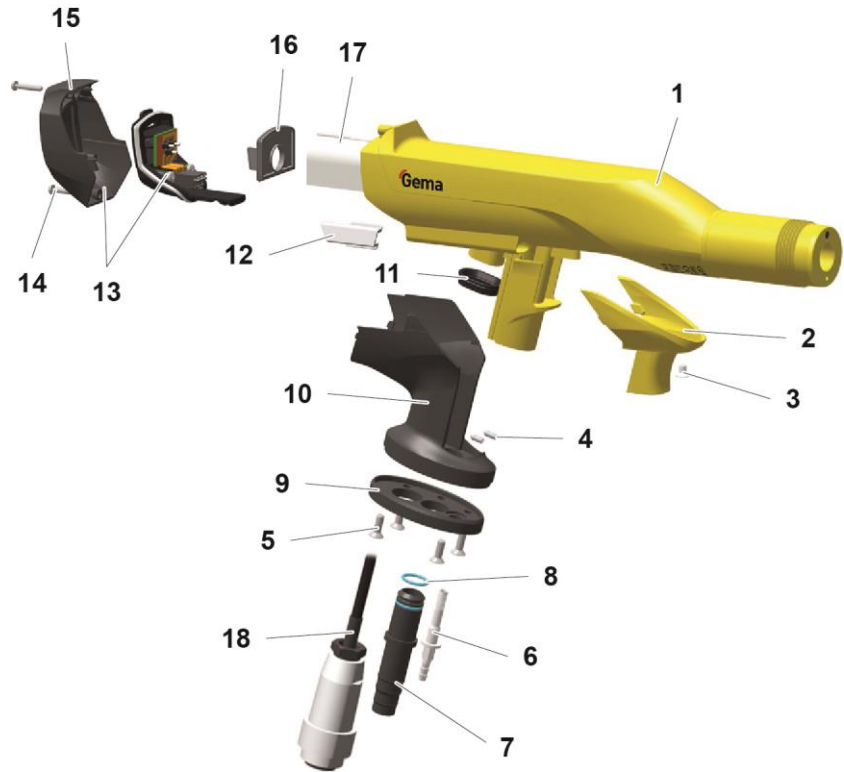

Fig. 12: Powder gun body



Fig. 13: Lid – Connections (cable numbers)

---

# SuperCorona

---

1	SuperCorona PC05	1008 165#
---	------------------	-----------

---

# Wearing part

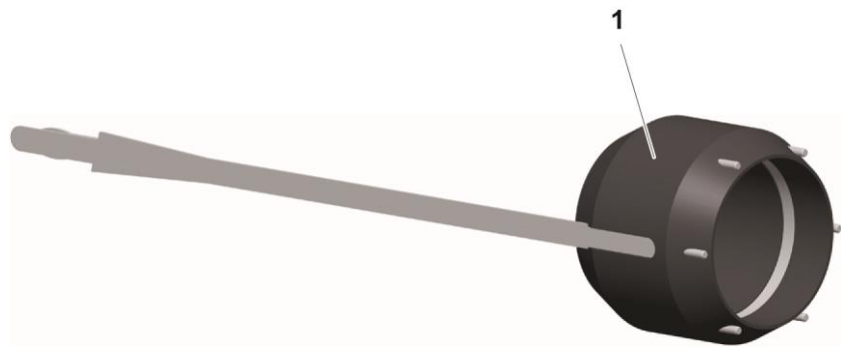









Fig. 14



## Accessories

### Flat jet nozzle – Overview (wearing parts)







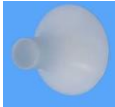

Application	A	B	A + B	Threaded sleeve
Profiles/flat parts (standard nozzle)	 NF27 1010 752		<b>NF27</b> 1010 754	
Profiles/flat parts	 NF20 1010 090	 1007 683	<b>NF20</b> 1010160	 1007 229
Complex profiles and depressions	 NF21 1007 935		<b>NF21</b> 1007 932	
Large surfaces	 NF24* 1008 147		<b>NF24</b> 1008 142	 1008 326

\* not suitable for angled nozzles

## Round jet nozzle – Overview (wearing parts)

Application	A	B	A + B	Threaded sleeve	Deflectors
Suitable for large surfaces	 NS04 1008 151	 1008 152	<b>NS04</b> 1008 150	 1007 229	 Ø 16 mm 331 341
					Ø 24 mm 331 333
					Ø 32 mm 331 325
					Ø 50 mm 345 822

## Gun extensions

Gun extensions		
	L = 150 mm	L = 300 mm
without nozzle <sup>1</sup>	 1008 616	 1008 617
without nozzle <sup>2</sup>	 1007 718	 1007 719
with Flat jet nozzle NF25	 1007 746	 1007 747
with Round jet nozzle NS09	 1007 748	 1007 749

<sup>1</sup> see NF27, NF20, NF21, NF24, NS04

<sup>2</sup> see NF25, NF26, NS09

### ATTENTION

#### Connecting more than two extensions

It is not permitted to connect more than two extensions together, in order to prevent the gun from being damaged by arising leverage force.

- ▶ The extensions (150 mm/300 mm) may be connected TO ONLY ONE ADDITIONAL extension (150 mm/300 mm), if necessary.





### Spray nozzles for extensions – overview (wearing parts)



1007 718

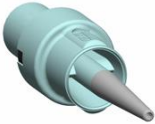

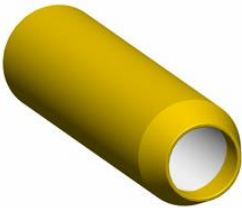
1007 719

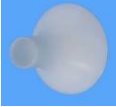
Application	A	B	A + B	Threaded sleeve	Deflectors
Profiles/flat parts	 NF25 1007 735	 1007 684	<b>NF25</b> 1007 743		--
Complex profiles and depressions	 NF26 1007 742		<b>NF26</b> 1007 744		 1007 740
Suitable for large surfaces	 NS09 1008 257	 1008 258	<b>NS09</b> 1008 259		 Ø 16 mm 331 341
					Ø 24 mm 331 333
					Ø 32 mm 331 325
					Ø 50 mm 345 822

## Diffusor– Spare parts list

<b>Diffuser – complete</b>		<b>1013 999</b>
1	Powder hose – Ø 11 mm	105 139*#
2	Adapter piece	1013 998
3	O-ring – Ø 13x1.5 mm, NBR70	1009 943
4	Fluidizing tube	1005 262#
5	Connector	1011 634
6	Screw-in nipple – M7-Ø 6 mm	1008 699
7	Plastic tube – Ø 6/4 mm	103 144*
8	Plug-in connector – Ø 6-Ø 8 mm	254 894

\* Please indicate length

# Wearing part

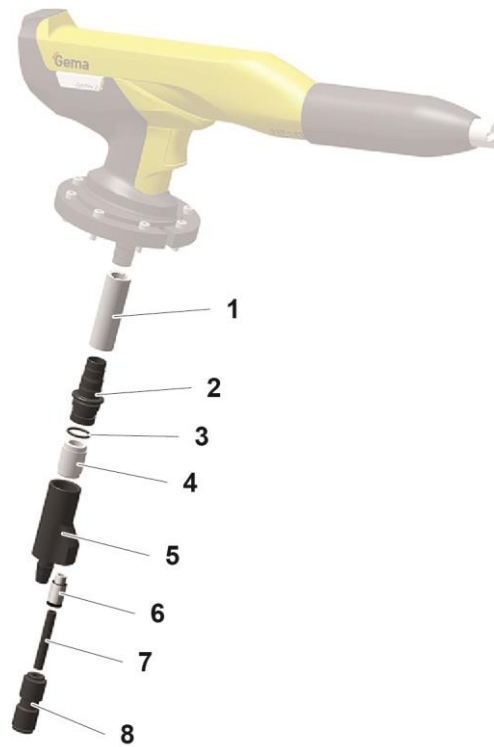

Fig. 15: Diffuser



# Index

## A

About these instructions.....	5
Assembly.....	21

## B

Basic safety instructions.....	7
--------------------------------	---

## C

Cleaning.....	31
Connection.....	21

## D

Decommissioning.....	29
Diffuser.....	48
Disposal.....	37
Disposal regulations.....	37
Disuse for several days.....	29

## E

Electrical data.....	12
----------------------	----

## F

Fault clearance.....	35
Figure references in the text.....	6
Fitting the gun.....	12

## G

Guidelines, European.....	10
---------------------------	----

## I

Intended use.....	9
-------------------	---

## M

Maintenance.....	31
Maintenance during storage.....	30

## N

Nozzles	
Round jet nozzle.....	18

## O

Operation.....	25
----------------	----

## P

Pictograms.....	5
Presentation of the contents.....	6
Product description.....	9
Product specific security regulations.....	7

## R

Repairs.....	31
--------------	----

## S

Safety.....	7
Safety symbols.....	5
Shutdown.....	29
Spare parts list.....	39
Standards, European.....	10
Start-up.....	23
Storage.....	29
Storage conditions.....	29

## T

Technical Data.....	11
---------------------	----

